



grass valley

A **BELDEN** BRAND

T2 4K Series

Digital Recorder/Players

Service Manual

Version 3.1.0

www.grassvalley.com

F3771909012
September 2019

Copyright

Copyright 2012 - 2019 Grass Valley. All rights reserved. Portions of software © 2000 - 2019, Microsoft Corporation. All rights reserved. This document may not be copied in whole or in part, or otherwise reproduced except as specifically permitted under U.S. copyright law, without the prior written consent of Grass Valley, Inc., 125 Crown Point Court Grass Valley, CA, 95945. This product may be covered by one or more U.S. and foreign patents. Grass Valley is a trademark of GVBB Holdings S.a.r.l.

Disclaimer

Product options and specifications subject to change without notice. The information in this manual is furnished for informational use only, is subject to change without notice, and should not be construed as a commitment by Grass Valley, Inc. Grass Valley, Inc. assumes no responsibility or liability for any errors or inaccuracies that may appear in this publication.

**U.S. Government
Restricted Rights
Legend**

Use, duplication, or disclosure by the United States Government is subject to restrictions as set forth in subparagraph (c)(1)(ii) of the Rights in Technical Data and Computer Software clause at DFARS 252.277-7013 or in subparagraph c(1) and (2) of the Commercial Computer Software Restricted Rights clause at FAR 52.227-19, as applicable. Manufacturer is Grass Valley, Inc., 125 Crown Point Court Grass Valley, CA, 95945 U.S.A.

**Trademarks and
Logos**

Belden, Belden Sending All The Right Signals and the Belden logo are trademarks or registered trademarks of Belden Inc. or its affiliated companies in the United States and other jurisdictions.

Other trademarks and logos used in this document are either registered trademarks or trademarks of the manufacturers or vendors of the associated products, such as Microsoft® Windows® operating system, Windows Media® player, Internet Explorer® internet browser, and SQL Server™. Intel, Core i7 are the trademarks or registered trademarks of Intel Corporation or its subsidiaries in the United States of America and other countries.

Grass Valley Web Site

This public Web site contains all the latest manuals and documentation, and additional support information. Use the following URL.
<http://www.grassvalley.com>.

Manual Explanation

- If there are any variations between the explanation in this manual and the actual application method, priority is given to the actual application method.
- This manual is a common manual for T2 4K Series. Screenshots and illustrations in this manual may vary from those of the actual product.
- The screenshots used as examples in this manual are those of the development stage, so they may vary from those in the final product.
- This manual is written for users who have a basic knowledge of how to use a computer.
- If there are no special instructions, perform the same operation as a normal computer operation.
- The contents of this product may modify without prior notice.

T2 4K Series Service Manual
Version 3.1.0

Copyright © 2018-2019 Grass Valley. All rights reserved.

Contents

	Contents	3
	Safety Summaries	5
	Finding Information	9
Chapter 1	Product Description	
	System Description	12
	PC Subsystem	13
	Front Subsystem	13
	Video I/O Board Type	14
	T2 orientation	15
	FRU locations	15
	Status indicators	16
	Power LED	16
	LAN port LED status	16
Chapter 2	Maintenance Procedures	
	Daily care of LCD touch screen	18
	About T2 modes	18
	Access maintenance mode	19
	Exiting the maintenance mode	20
	Using the Maintenance Tools	22
	Closing the Maintenance Tools	22
	Media drive maintenance	23
	Data maintenance	26
	System related maintenance	32
	Media drive RAID volume maintenance	36
	Verifying the RAID status	36
	Building the RAID volume	38
	Restoring to the factory default condition	49
Chapter 3	Troubleshooting Problems	
	Step 1: Check configurations	52
	Step 2: Check connections and external equipment	52
	Shutdown/restart problems	52
	Checking external equipment	53
	PC monitor problems	53
	Keyboard problems	53
	Mouse problems	54
	Motherboard/BIOS startup	54
	T2 startup	55
	Thermal problems	55
	Power supply problems	55
	Common to all models	55
	Only T2 4K Elite	56
	Front panel problems	56
	LCD touch screen and operation buttons problems	56
	Front USB group unit problems	57
	Media card reader problems (T2 4K Elite only)	58
	Timecode problems	59
	Operational problems	59
	Storage problems	60
	Media File System problems	60
	Media drive problems	60
	Checking the storage system	61

Chapter 4	Removing and replacing FRUs	
	Precautions before operations	64
	Required tools	64
	Turning off the T2 and disconnecting the power cord	64
	Removing the top cover (rear)	66
	Removing the top cover (front).....	67
	Removing data HDD/SSD	69
	Data HDD/SSD SATA cable connection	70
	Removing system SSD	71
	Removing the power supply status LED board (T2 4K Elite only).....	72
	Removing the media card reader assy (T2 4K Elite only)	74
	Removing the front panel	76
	Removing the Jog/Shuttle knob	77
	Removing the front USB group unit	77
	Removing the system USB stick	80
	Removing the LCD touch screen	81
	Removing the button kit	84
	Removing RAM module	85
	Removing the mid-cooling fan.....	86
	Removing the front cooling fan	89
	Removing the rear fan.....	90
	Removing LTC/Monitor audio interface board	91
	Removing the video I/O board	93
	Removing the remote interface board.....	94
	Removing VGA card	95
	Removing the power supply unit.....	96
	Removing the power supply unit enclosure	97
	Index	99

Safety Summaries

General Safety Summary

Review the following safety precautions to avoid injury and prevent damage to this product or any products connected to it.

While using this product, you may need to access other parts of the system. Read the *General Safety Summary* in other system manuals for warnings and cautions related to operating the system.

Injury Precautions

Use Proper Power Cord

To avoid fire hazard, use only the power cord specified for this product.

Ground the Product

This product is grounded through the grounding conductor of the power cord. To avoid electric shock, the grounding conductor must be connected to earth ground. Before making connections to the input or output terminals of the product, ensure that the product is properly grounded.

Do Not Operate Without Covers

To avoid electric shock or fire hazard, do not operate this product with covers or panels removed.

Do Not Operate in Wet/Damp Conditions

To avoid electric shock, do not operate this product in wet or damp conditions.

Do Not Operate in an Explosive Atmosphere

To avoid injury or fire hazard, do not operate this product in an explosive atmosphere.

Avoid Exposed Circuitry

To avoid injury, remove jewelry such as rings, watches, and other metallic objects. Do not touch exposed connections and components when power is present.

Product Damage Precautions

Use Proper Power Source

Do not operate this product from a power source that applies more than the voltage specified.

Provide Proper Ventilation

To prevent product overheating, provide proper ventilation.

Do Not Operate With Suspected Failures

If you suspect there is damage to this product, have it inspected by qualified service personnel.

Battery Replacement

To avoid damage, a battery must be replaced once every five years. Please contact Grass Valley Product Support to replace the battery.

Safety Terms and Symbols

Terms in This Manual

These terms may appear in this manual:

 **WARNING:** *Warning statements identify conditions or practices that can result in personal injury or loss of life.*

 **CAUTION:** *Caution statements identify conditions or practices that may result in damage to equipment or other property, or which may cause equipment crucial to your business environment to become temporarily non-operational.*

Terms on the Product

These terms may appear on the product:

DANGER indicates a personal injury hazard immediately accessible as one reads the marking.

WARNING indicates a personal injury hazard not immediately accessible as you read the marking.

CAUTION indicates a hazard to property including the product.

Symbols on the Product

The following symbols may appear on the product:

 DANGER high voltage

 Protective ground (earth) terminal

 ATTENTION – refer to manual

Service Safety Summary

 **WARNING:** *The service instructions in this manual are intended for use by qualified service personnel only. To avoid personal injury, do not perform any servicing unless you are qualified to do so. Refer to all safety summaries before performing service.*

Do Not Service Alone

Do not perform internal service or adjustment of this product unless another person capable of rendering first aid and resuscitation is present.

Disconnect Power

To avoid electric shock, disconnect the main power by means of the power cord or, if provided, the power switch.

Use Care When Servicing With Power On

Dangerous voltages or currents may exist in this product. Disconnect power and remove battery (if applicable) before removing protective panels, soldering, or replacing components.

To avoid electric shock, do not touch exposed connections.

Certifications and Compliances

Canadian Certified Power Cords

Products that are relocated to other countries should use nationally certified power cords and plugs to ensure safe operation of the product.

FCC Emission Control

This equipment has been tested and found to comply with the limits for a Class A digital device, pursuant to Part 15 of the FCC Rules. These limits are designed to provide reasonable protection against harmful interference when the equipment is operated in a commercial environment. This equipment generates, uses, and can radiate radio frequency energy and, if not installed and used in accordance with the instruction manual, may cause harmful interference to radio communications. Operation of this equipment in a residential area is likely to cause harmful interference in which case the user will be required to correct the interference at his own expense. Changes or modifications not expressly approved by Grass Valley can affect emission compliance and could void the user's authority to operate this equipment.

Canadian EMC Notice of Compliance

This digital apparatus does not exceed the Class A limits for radio noise emissions from digital apparatus set out in the Radio Interference Regulations of the Canadian Department of Communications.

This product must not be used in residential areas.

**EMC Directive
Class A Warning**

This product must not be used in residential areas.

FCC Emission Limits

This device complies with Part 15 of the FCC Rules. Operation is subject to the following two conditions: (1) This device may not cause harmful interference, and (2) this device must accept any interference received, including interference that may cause undesirable operation.

Finding Information

This Service Manual provides procedures for assessing and solving technical problems and performing routine maintenance on your T2.

The T2 has two types of operation: Front Panel Mode and Workstation Mode. Front panel mode allows you to operate the T2 using the touch screen or a mouse while looking at the LCD touch screen. Workstation Mode allows you to operate the T2 using a mouse or keyboard while looking at PC monitor connected to the T2.

This service manual mainly documents procedures of the Front Panel Mode using a mouse unless otherwise documented, procedures for operations with the Workstation Mode are also the same as for the Front Panel Mode.

How this manual is organized

This Service Manual consists of the following:

Chapter 1, *Product Description:*

Describes system components, locations of the Field Replaceable Units (FRUs), and status indicators of the T2.

Chapter 2, *Maintenance Procedures:*

Contains procedures for periodic maintenance.

Chapter 3, *Troubleshooting Problems:*

Contains problem descriptions with steps for diagnosing and correcting the cause of the problem. Use this information if you are having trouble with your T2.

Chapter 4, *Removing and replacing FRUs:*

Contains procedures for removing and replacing the Field Replaceable Units (FRUs).

Chapter 1

Product Description

This chapter consists of the following:

- "System Description" on page 12
 - "PC Subsystem" on page 13
 - "Front Subsystem" on page 13
 - "Video I/O Board Type" on page 14
- "T2 orientation" on page 15
 - "FRU locations" on page 15
- "Status indicators" on page 16
 - "Power LED" on page 16
 - "LAN port LED status" on page 16

System Description

The T2 is Windows computer-based video disc recorder.

This section explains the major architectural blocks.

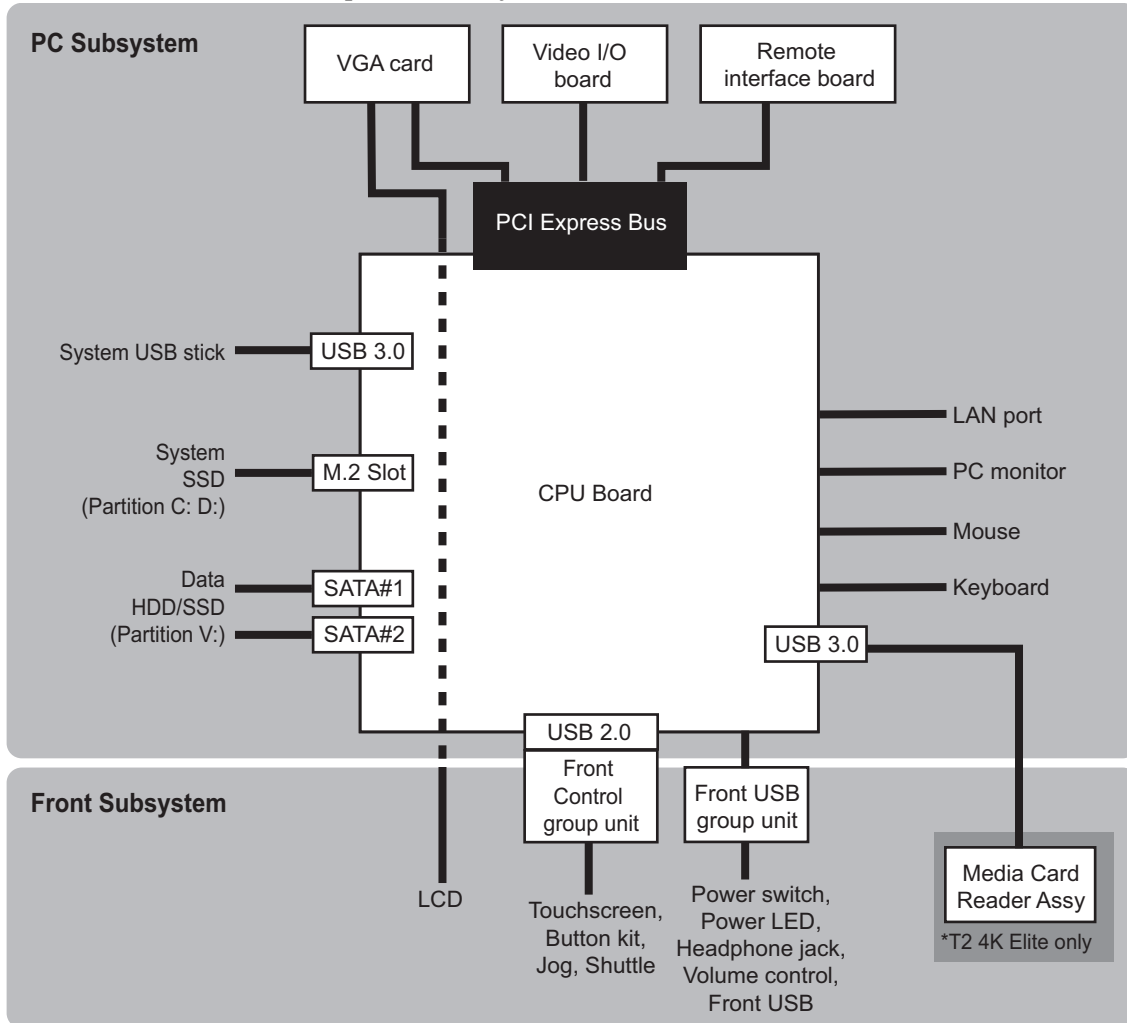

PC Subsystem

The PC subsystem is intended to run application software running on top of a Windows OS.

This subsystem includes the following components:

- CPU board
- Intel Core i7 processor
- 16GB DDR 4 memory
- 2x LAN ports
- System image USB stick
- Data HDD/SSD
- 2x monitor ports (DVI-D/DisplayPort)
- M.2 System SSD
- Power supply unit
- Video I/O board
- Remote interface board
4x RS-422, 1x GPIO

Front Subsystem

The front subsystem provides user interfaces such as LCD, Jog/Shuttle knob and operation buttons.

This subsystem includes the following components:

- Front USB group unit
The front USB group unit interconnects power switch, power LED, headphone jack, volume dial, two USB 3.0 ports.
- Front Control group unit
This board consists of operation buttons, Jog/Shuttle knob, and LCD.

Video I/O Board Type

The specifications of the mounted video I/O board differ depending on the model of T2 4K Series.

Although they are different visually, the mounting/unmounting procedure is the same.

Video I/O board mounted on T2 4K Series (T2 4K Elite/T2 4K Pro/T2 4K Express)



Product name	Model number
T2 4K Elite	KTR4-ELT-CV40
T2 4K Pro	KTR4-PRO-CV40
T2 4K Express	KTR4-EXP-CV40

T2 4K I/O Card Kit (SDI x8) which supports T2 4K Series Plus (T2 4K Elite (No I/O card)/T2 4K Pro (No I/O card)/T2 4K Express (No I/O card))



Product name	Model number	Model number of I/O Card Kit
T2 4K Elite (No I/O card)	KTR4-ELT-CV00	KTR4-IO-CV80-KIT
T2 4K Pro (No I/O card)	KTR4-PRO-CV00	
T2 4K Express (No I/O card)	KTR4-EXP-CV00	

T2 orientation

FRU locations

The following illustration shows the location of Field Replaceable Units (FRUs) and other components in the T2.

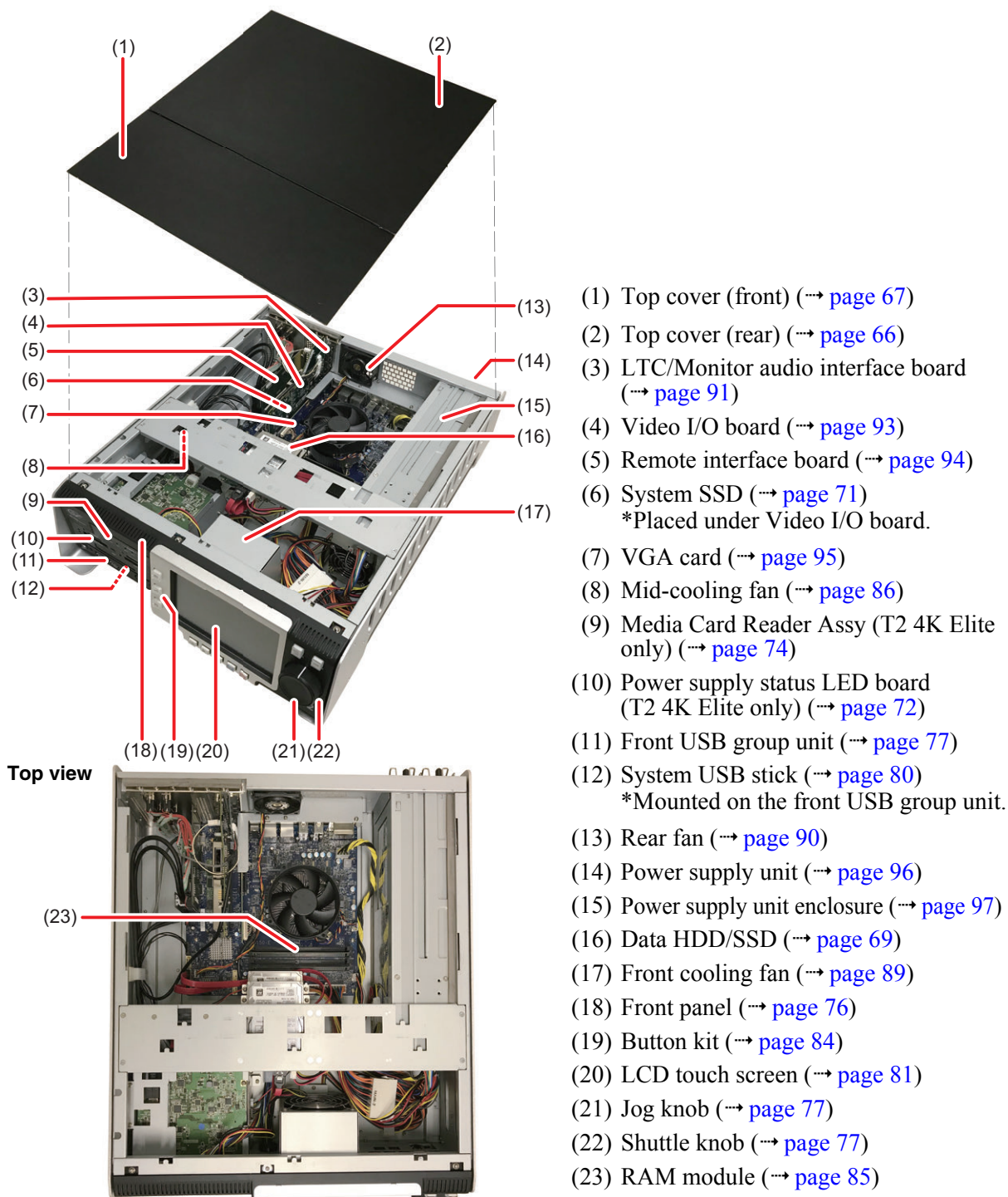

Status indicators

The following sections describe the visual indicators that communicate the current operating status and system health of the T2.

Power LED

The Power LED indicates status as follows:

LED behavior	Status Condition
Off	The power is set to Off and the T2 is not operational.
Green steady on	The power is set to On and the T2 is operational.

 **WARNING:** *The power switch does not turn off power to the system. To turn power off, the system must be disconnected from the power source.*

LAN port LED status

The RJ-45 LAN port includes integrated status LEDs. The LEDs oriented as follows:

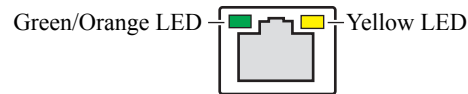

The meanings of the LED states are described in the following table:

LED	Color	LED state	Status Condition
Right	Yellow	Off	LAN link is not established.
		On	LAN link is established.
		Flashing	The computer is communicating with another computer on the LAN.
Left	Green	Off	10 Mbit/sec data rate is selected / No connection has been detected.
		On	100 Mbit/sec data rate is selected.
	Orange	On	1000 Mbit/sec data rate is selected.

Maintenance Procedures

This chapter consists of the following:

- "Daily care of LCD touch screen" on page 18
- "About T2 modes" on page 18
 - "Access maintenance mode" on page 19
 - "Exiting the maintenance mode" on page 20
- "Using the Maintenance Tools" on page 22
 - "Closing the Maintenance Tools" on page 22
 - "Media drive maintenance" on page 23
 - "Data maintenance" on page 26
 - "System related maintenance" on page 32
- "Media drive RAID volume maintenance" on page 36
 - "Verifying the RAID status" on page 36
 - "Building the RAID volume" on page 38
- "Restoring to the factory default condition" on page 49

Daily care of LCD touch screen

The LCD touch screen requires good daily care. Wipe away moisture, sweat, fingerprint or dirt with a soft dry cloth.

About T2 modes

The T2 operates in the following modes:

- CommandCenter mode
The CommandCenter is automatically launched at startup.
- Maintenance mode
The CommandCenter application is closed and the Windows operating system desktop is available for system operations such as data maintenance, RAID volume maintenance, and software update.

 **CAUTION:** *The T2 is not a general purpose Windows workstation. The T2 is designed so that a user can start it up without an administrator privilege to log on to the system automatically. Do not modify any system settings unless approved by Grass Valley. A partial or total system failure may result.*

- Do not use the User Accounts on the T2.
- Do not install any third party software not provided by Grass Valley on the T2.

Access maintenance mode

⚠ CAUTION: You must terminate all of recording, playback, and file transfer (import/export/FTP transfer) operations to stop accessing the media prior to performing operations.

NOTE: If a keyboard and mouse have not been connected, shut down the T2, connect a keyboard and mouse, and start up the T2. Refer to ["Force start in maintenance mode" on page 19](#).

1. Switch to **1ch View**, touch **Menu**, and then touch **Tools** → **Maintenance**.
 - When operating in the workstation mode, click **System** from the menu bar and then click **Maintenance...**
2. Touch the entry field on the password entry screen.
3. Enter "admin", and touch **OK**.
4. Touch **OK**.
5. Touch **Yes** when the confirmation message is displayed.
 - The CommandCenter is closed and the system restarts in the maintenance mode.
 - After the restart, the Maintenance Tools is launched automatically.

Force start in maintenance mode

1. Turn on the T2 then immediately keep to press both **SHTL/JOG** and **VAR** button.
 - Keep pressing the **SHTL/JOG** and **VAR** buttons until a message "Now switching to Maintenance mode. The system is rebooting..." is displayed in the LCD touch screen.



- The T2 will start in the maintenance mode.

Exiting the maintenance mode

Returning to the CommandCenter mode

Once you finish T2 maintenance, use this procedure to return to the CommandCenter mode.

1. In the Maintenance Tools main screen, select **CommandCenter** under "Next Boot Mode".

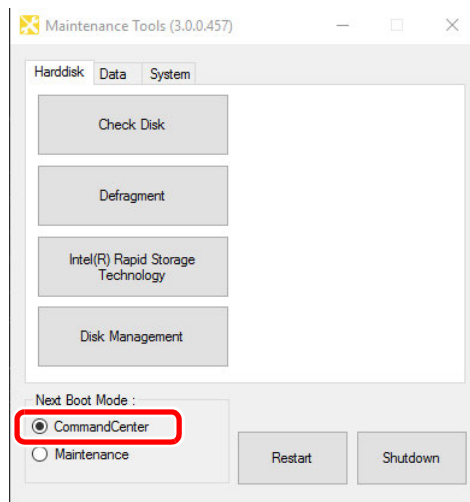

2. Click **Restart**.
 - Restart the T2 in the CommandCenter mode.

Restarting the T2 in maintenance mode

Use this procedure if you want to restart the T2 further maintenance.

NOTE: *If the Maintenance Tools is not running in the maintenance mode, performing the normal restart operation from the Windows desktop will restart your system without exiting the maintenance mode.*

1. In the Maintenance Tools main screen, select **Maintenance** under "Next Boot Mode".

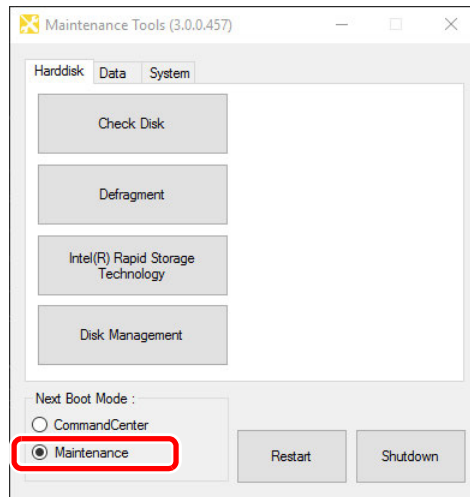

2. Click **Restart**.

- After the restart, the Maintenance Tools is launched automatically.

Exiting the maintenance mode to shut down

In the Maintenance Tools main screen, click **Shutdown**.

- The T2 will start in the mode you selected last time when the T2 is turned on next time.

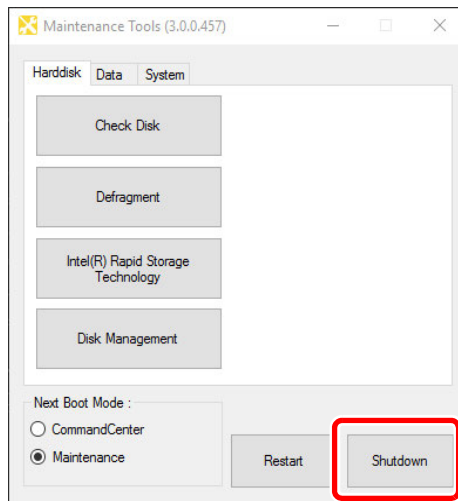

Using the Maintenance Tools

The Maintenance Tools is software for performing maintenance procedures such as running a failure diagnosis on the T2 or backing up data.

- Media drive maintenance
 - "Check Media drive error" on page 23
 - "Defragmentation of media drive" on page 24
- Data maintenance
 - "Checking the data consistency" on page 26
 - "Initializing the data" on page 28
 - "Backing up the data" on page 29
 - "Restoring the data" on page 31
- System related maintenance
 - "Gathering system information" on page 32
 - "Gathering log files" on page 34
 - "Setting the T2 system clock" on page 35

Closing the Maintenance Tools

1. In the Maintenance Tools main screen, click **X**.

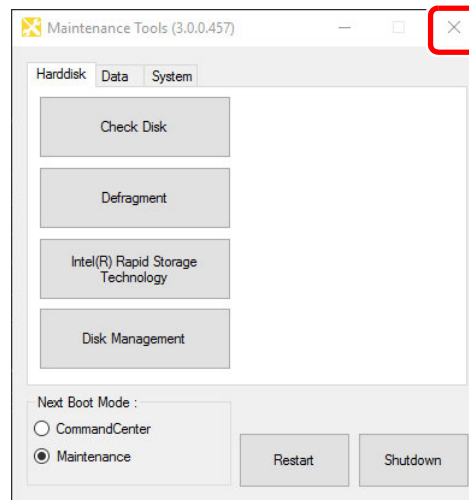

NOTE: To start up the Maintenance Tools, double-click the Maintenance Tools icon on the desktop.

Media drive maintenance

Check Media drive error

You can scan the media drive (V: drive) to check for any file system errors and bad sectors. If any error is found, the system attempts to restore the media drive.

1. In the Maintenance Tools main screen, select the **Harddisk** tab.

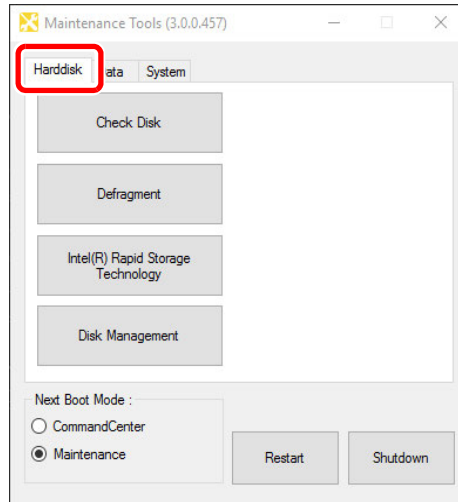

2. Click **Check Disk**.

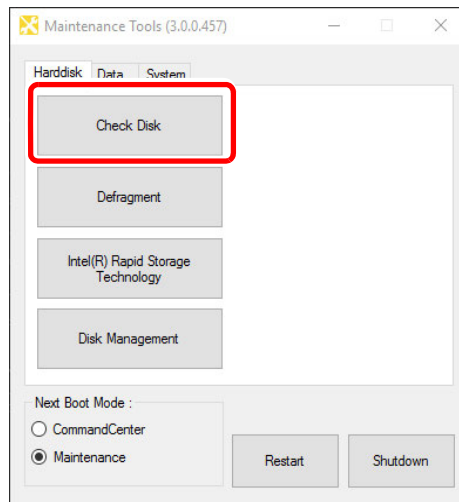

3. Check the items under "Options" as necessary, and then click **Start**.

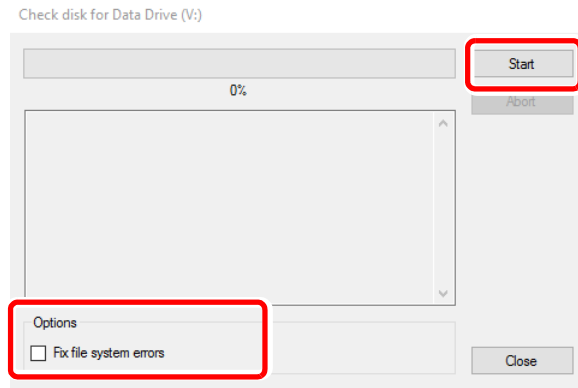

- If **Fix file system errors** is checked, the system fixes errors automatically without disk scan.
- To abort disk error check, click **Abort**.

4. When you see the completion message, click **Close**.

- "Check disk for Data Drive" screen is closed.

Defragmentation of media drive

1. In the Maintenance Tools main screen, select the **Harddisk** tab.

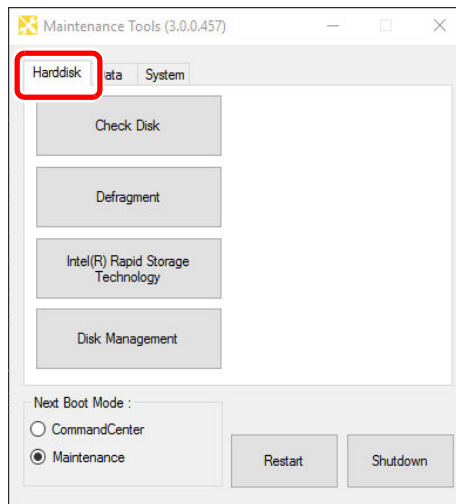

2. Click **Defragment**.

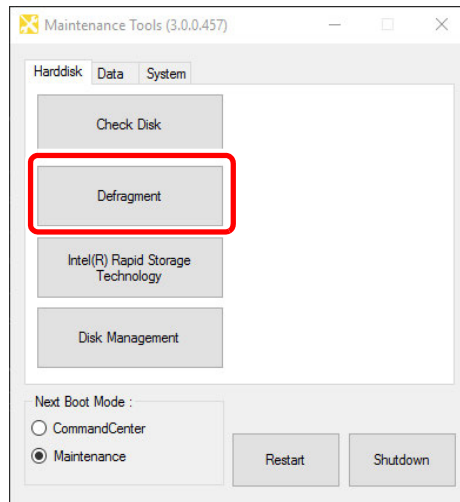

3. Click either **Analyze** or **Defragment**.

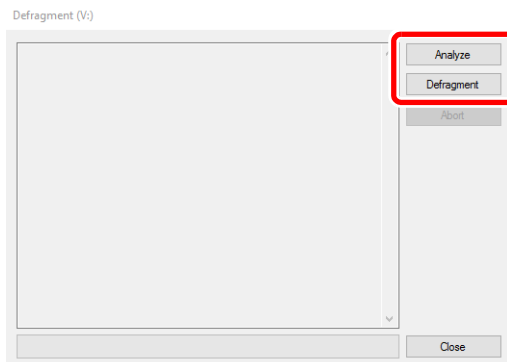

- **Analyze** only performs defragmenting analysis and result will appear.
- Clicking **Defragment** performs defragmentation.
- To abort optimizing the drive, click **Abort**.

4. When you see the completion message, click **Close**.

Data maintenance

Checking the data consistency

You can check the consistency between the database and the media files. Found inconsistency can be resolved by deleting listed item.

NOTE: Data in the Recycle Bin is not subject to this data consistency check.

1. In the Maintenance Tools main screen, select the **Data** tab.

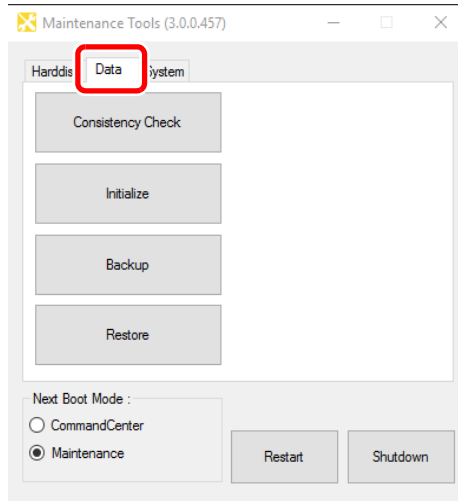

2. Click **Consistency Check**.

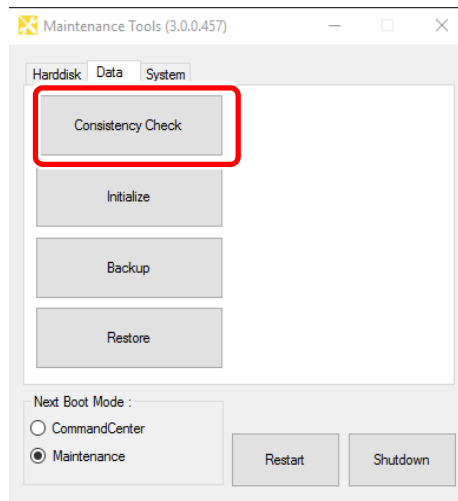

3. Click **Check Consistency**.

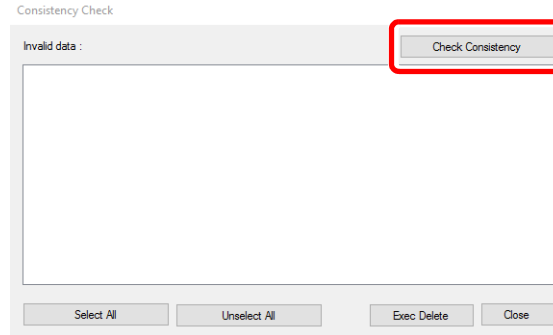

- Data consistency check will be performed and inconsistency will be listed.

4. Check the inconsistent information you want to delete, and then click **Exec Delete**.

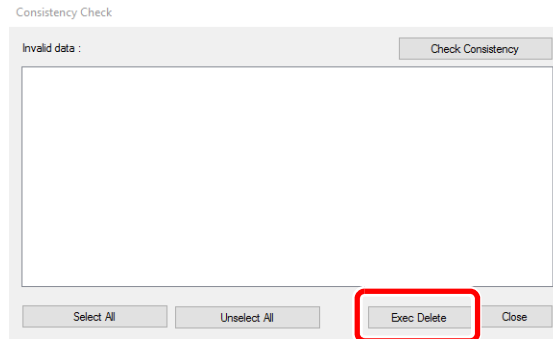

- All of listed items can be selected or deselected by clicking **Select All / Unselect All**.

5. Click **Close**.

Initializing the data

You can initialize the database, the media drive (V: drive), and configuration.

 **CAUTION: Current data will be lost. Backup the data beforehand.**

1. In the Maintenance Tools main screen, select the **Data** tab.

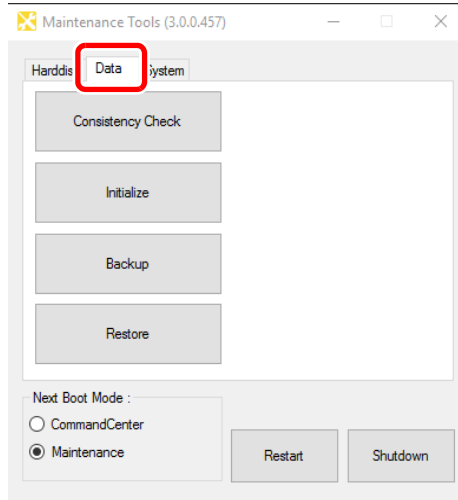

2. Click **Initialize**.

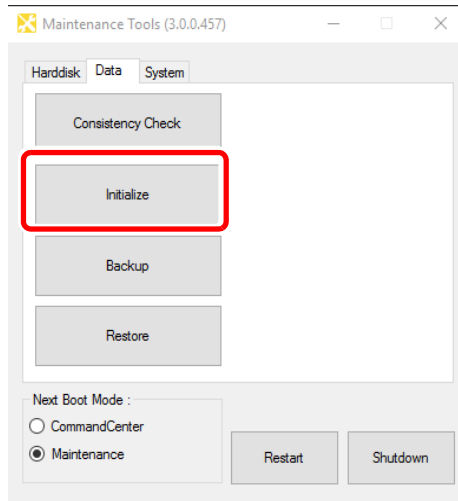

3. Check the items you want to initialize.

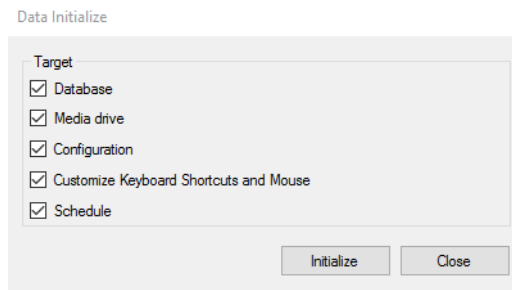

- **Database** - Delete the database contents.
- **Media drive** - Format the media drive and initialize the folder structure.
- **Configuration** - Initialize the configuration.
- **Customize Keyboard Shortcuts and Mouse** - Initialize the settings of the keyboard shortcuts and mouse customization.
- **Schedule** - Initialize the settings of Schedule Recording.
Schedule Recording function automatically starts capturing operation at a specified time, and ends it at a specified time in the R1-live mode. For more information, refer to the User Manual.

4. Click **Initialize**.
5. Click **Yes**.
 - Initialization will be performed for the selected item.
6. When you see the completion message, click **OK**.
7. Click **Close**.

Backing up the data

1. In the Maintenance Tools main screen, select the **Data** tab.

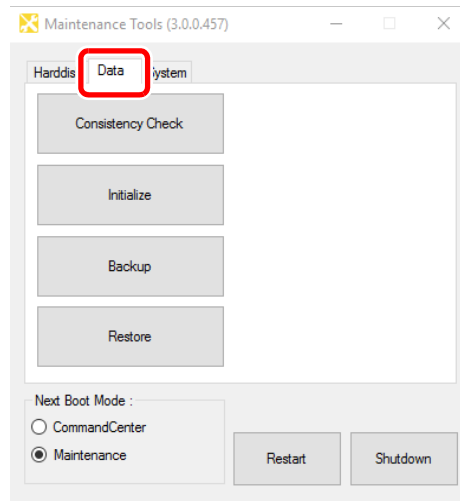

2. Click **Backup**.

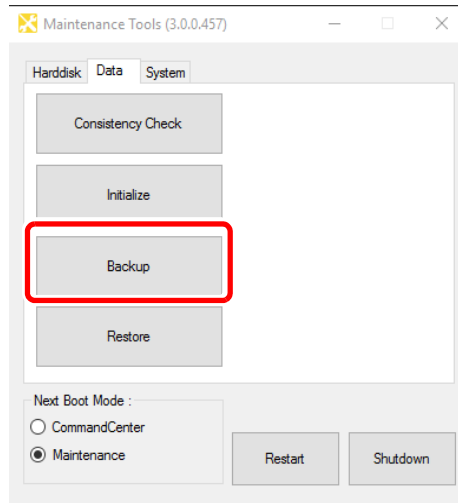

3. Click ... to specify the destination.

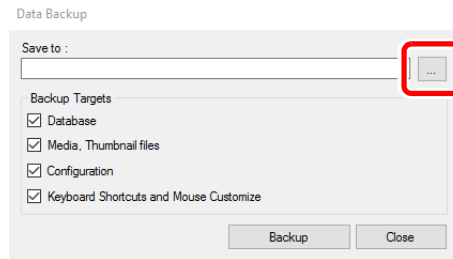

4. Check the target item(s) you want to back up under "Backup Targets".

- **Database** - Back up the database.
- **Media, Thumbnail files** - Back up the media files including the thumbnails.
- **Configuration** - Back up the Config settings.
- **Keyboard Shortcuts and Mouse Customize** - Back up the settings of the keyboard shortcuts and mouse customization.

5. Click **Backup**.

6. Click **Yes**.

- Backup will be performed for selected items.
A sub-folder named (yyyyymmdd) will be created, in which data will be stored.
Also, an XML file that describes the backup information will be stored.

7. When you see the completion message, click **OK**.

8. Click **Close**.

Restoring the data

You can restore the data of your backed up database, media files, and Config settings.

CAUTION: Restoring your data will delete all of the current data overwriting it with the source data for the restore.

1. In the Maintenance Tools main screen, select the **Data** tab.

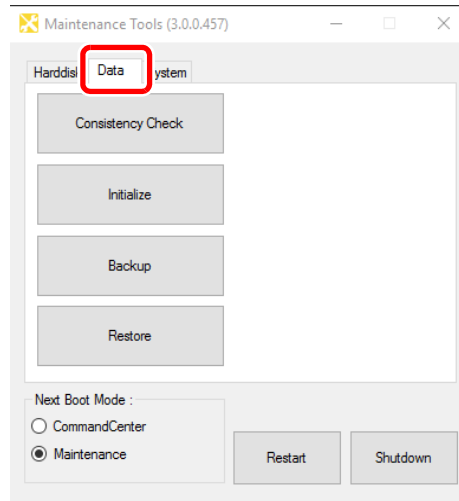

2. Click **Restore**.

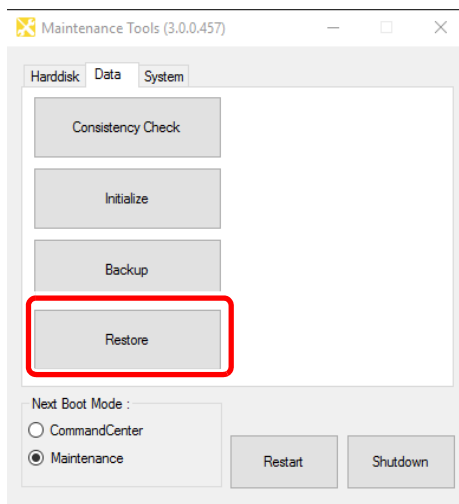

3. Click **Select** to specify the XML file created upon the backup.

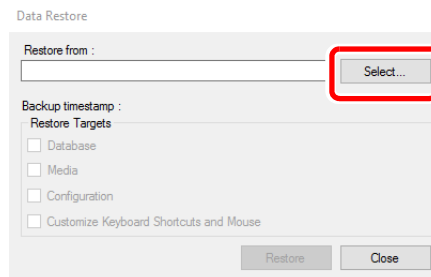

- "Backup timestamp" shows the backup date.
 - Among the items under "Restore Targets", any item(s) that exist in the same folder where the XML file is located will be checked.
4. Make sure that the data you want to restore are checked under "Restore Targets".
 - Uncheck any item that does not need to be restored.
 5. Click **Restore**.
 6. Click **Yes** when the confirmation message is displayed.
 - Data restoration will be performed.
 7. When you see the completion message, click **OK**.
 8. Click **Close**.

System related maintenance

Gathering system information

Use this procedure to gather T2 system related information. Grass Valley support may ask you to provide the log file set or system information that can be gathered by the procedure.

1. In the Maintenance Tools main screen, select the **System** tab.

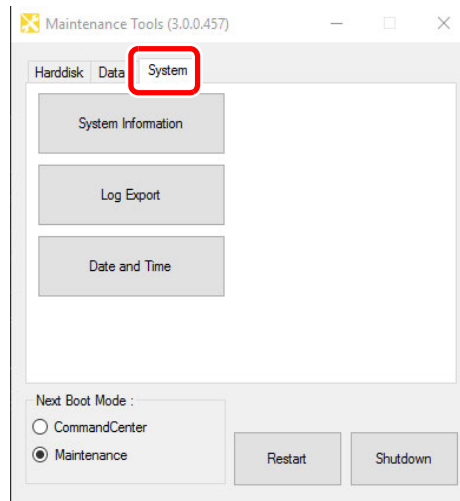

2. Click **System Information**.

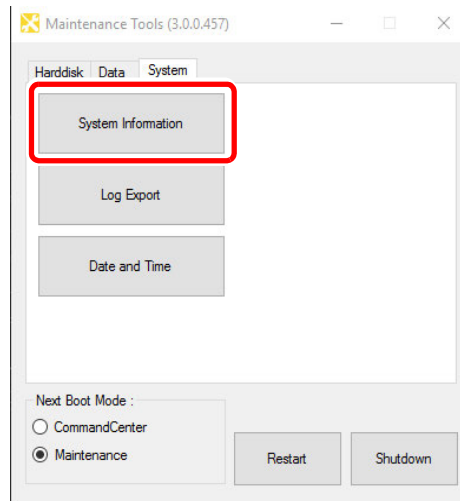

3. Click ... to specify the destination.

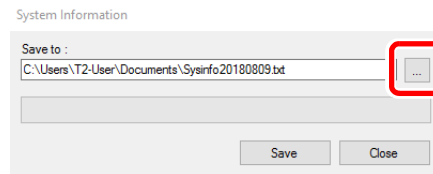

4. Click **Save**.

- Gathering the system information will be performed.

5. When you see the completion message, click **OK**.

- A text format file containing the system information is created in the specified destination.

6. Click **Close**.

- "System Information" screen is closed.

Gathering log files

T2 operation, process, database and Windows operating system event logs can be gathered.

1. In the Maintenance Tools main screen, select the **System** tab.

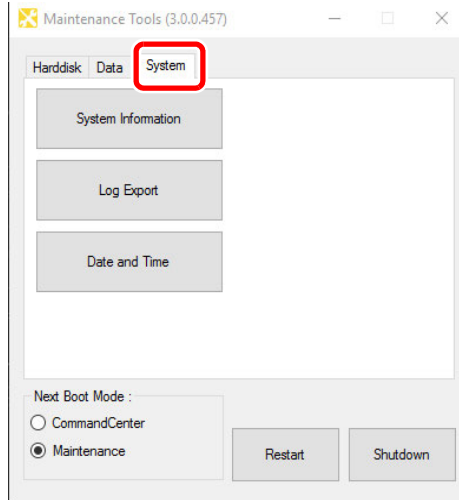

2. Click **Log Export**.

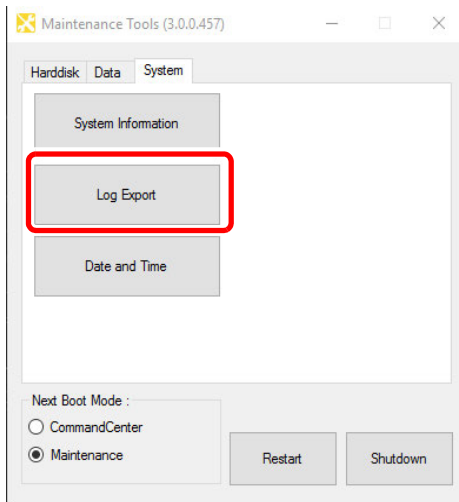

3. Check the log(s) you want to export under "Export targets".

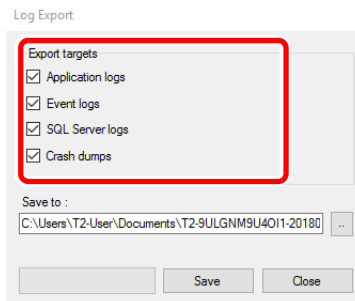

- **Application logs** - Export an operation log.

- **Event logs** - Export a Windows event log.
 - **SQL Server logs** - Export a database log.
 - **Crash dumps** - Export a crash dumps file.
4. Click ... to specify the destination and a file name.
 5. Click **Save**.
 6. When you see the completion message, click **OK**.
 - Log zip file will be stored in the destination.
 7. Click **Close**.

Setting the T2 system clock

1. In the Maintenance Tools main screen, select the **System** tab.

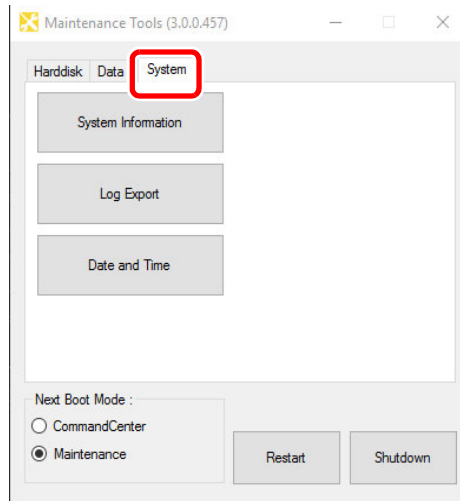

2. Click **Date and Time**.

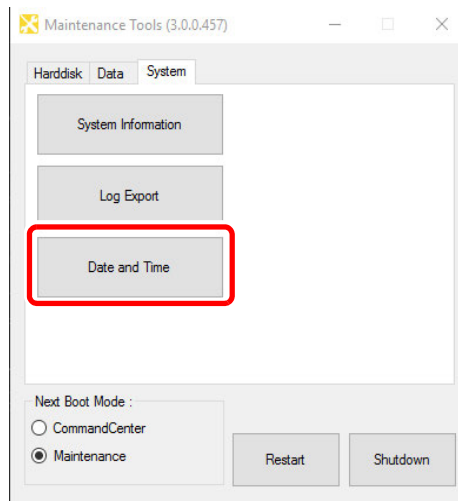

- The Windows Date and Time screen will appear, change the date and time, and TimeZone.

3. Click **OK**.

Media drive RAID volume maintenance

The media drive RAID volume is always monitored. If any problem occurs on the RAID volume, the icon () is displayed at the right-pane for the Front Panel Mode or on the status bar of the Workstation Mode to notify occurrence of the problem. If the RAID volume cannot be configured, the T2 starts up in the maintenance mode even when starting up in the CommandCenter mode.

Following the procedure described below, you can verify the RAID volume to identify any failed drive(s) and build or rebuild the RAID volume after replacing the failed drive.

Verifying the RAID status

You can verify the current condition of the RAID volume to identify the failed drive(s).

1. Start up the T2 in the maintenance mode.
 - For more information, refer to "[Access maintenance mode](#)" on page 19.
2. In the Maintenance Tools main screen, select the **Harddisk** tab, and then click **Intel(R) Rapid Storage Technology**.

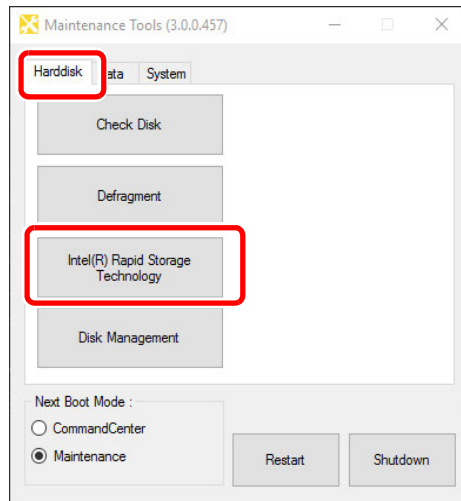

- Intel (R) Rapid Storage Technology application screen will appear.

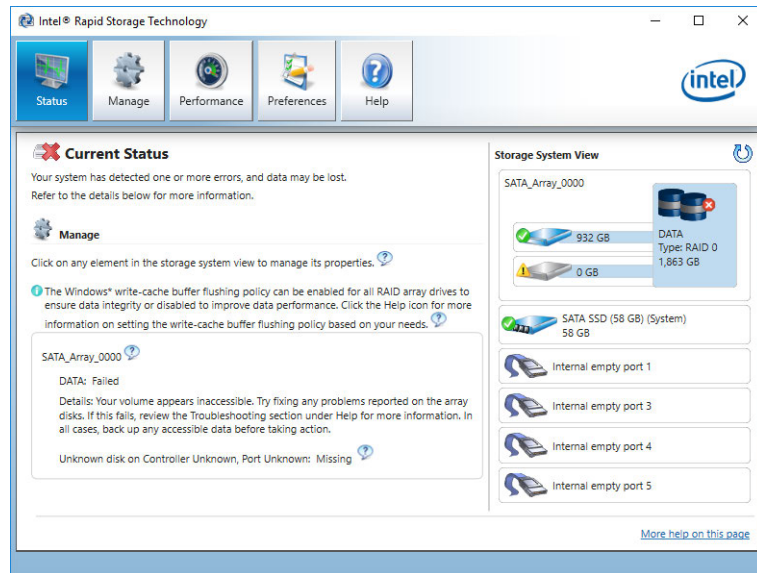

3. Click the device with the "!" mark in "Storage System View" at the right-pane.

- The numbers in "Port 1", "Port 2"...etc. are their drive numbers. The drives are sorted in the order of "SATA 1", "SATA 2" ...
- For a drive running normally, "Normal" is shown for "Status" of "Manage Disk" at the left-pane, and for a failed drive, "Missing" is shown.

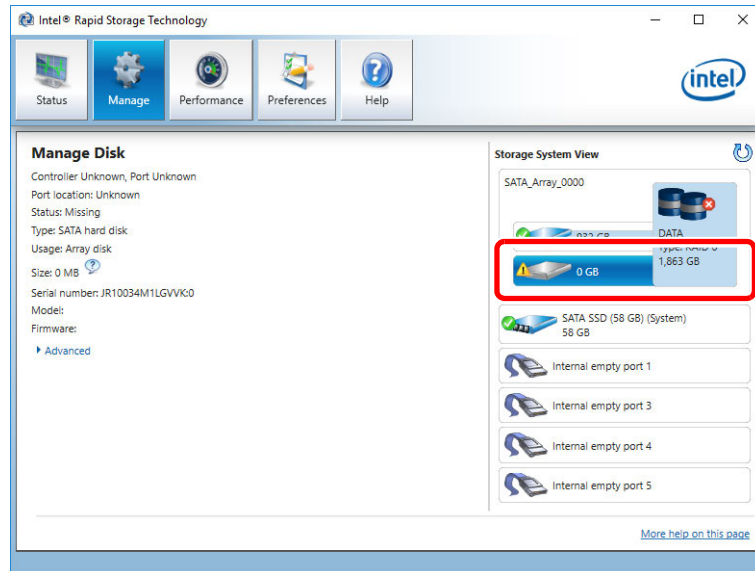

- If there is any failed drive, shut down the T2 as described in ["Exiting the maintenance mode to shut down"](#) on page 21, then replace the failed drive as described in ["Removing data HDD/SSD"](#) on page 69. After the drive has been replaced, rebuild the RAID volume as described in ["Building the RAID volume"](#) on page 38.

Building the RAID volume

Rebuild the RAID volume after the drive replacement.

1. Start up the T2 in the maintenance mode.
 - For more information, refer to "[Access maintenance mode](#)" on page 19.
2. In the Maintenance Tools main screen, select the **Harddisk** tab, and then click **Intel(R) Rapid Storage Technology**.

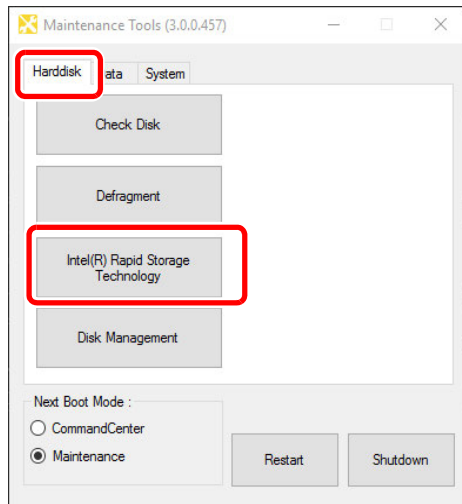

- Intel (R) Rapid Storage Technology application screen will appear.



3. Click the device with "SATA disk" in "Storage System View" at the right-pane.
 - Check whether the replaced drive is recognized.

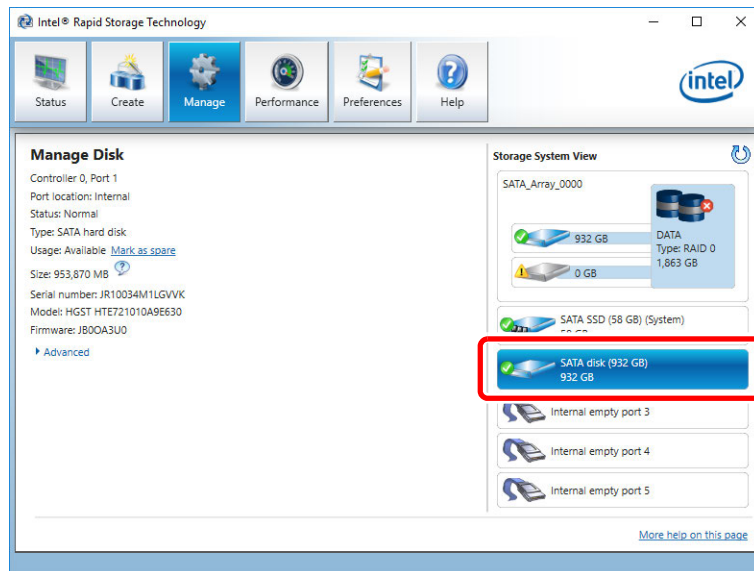

4. Click the "Data Type: RAID 0" section in "Storage System View" at the right-pane.

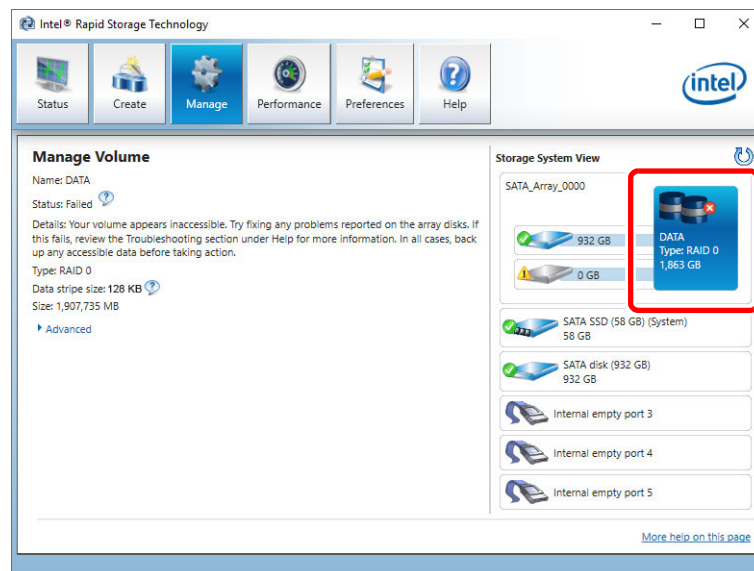

5. Click **Advanced** in "Manage Volume" at the left-pane, and then click **Delete volume**.

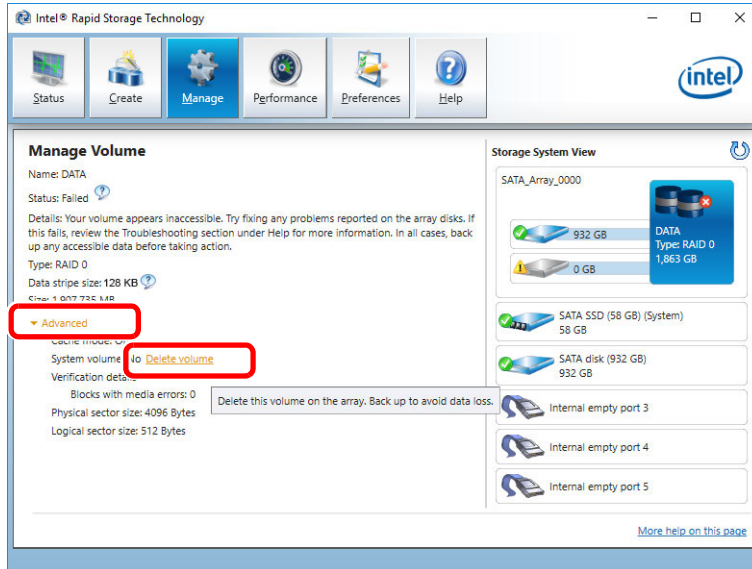

6. Click **Yes**.

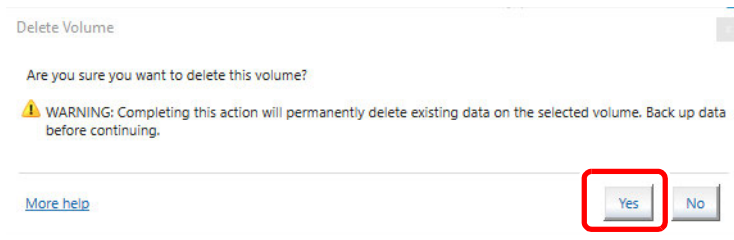

7. Click **Create**.

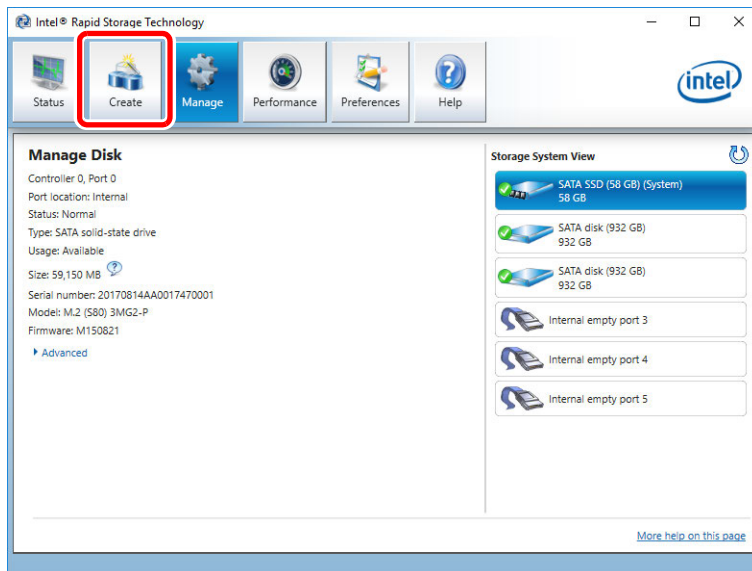

8. Select **SATA** in "Select Controller", and select **Optimized disk performance (RAID 0)** in "Select Volume Type", and then click **Next**.

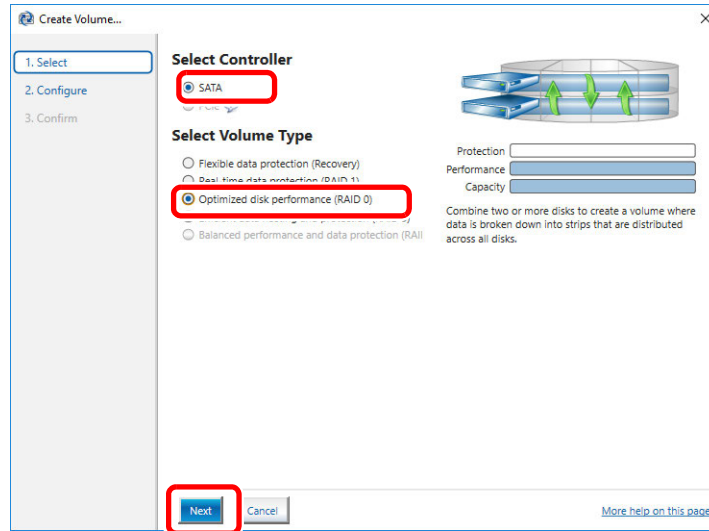

9. In "Configure Volume", configure each parameter as below. Once configured, click **Next**.

- (1) Name - DATA.
- (2) Select the array disks - check both **SATA disk on Controller 0, Port 1** and **Port 2**.
- (3) Advanced tab - Data Stripe Size - 128 KB.

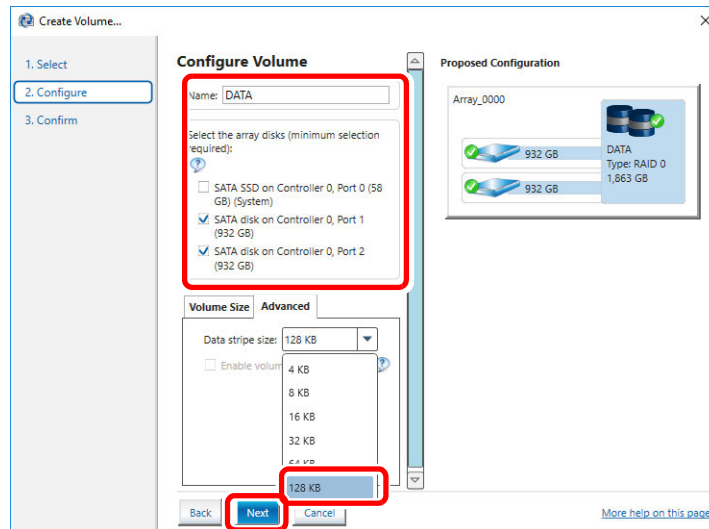

10. Check **Proceed with deleting data**, and then click **Create Volume**.

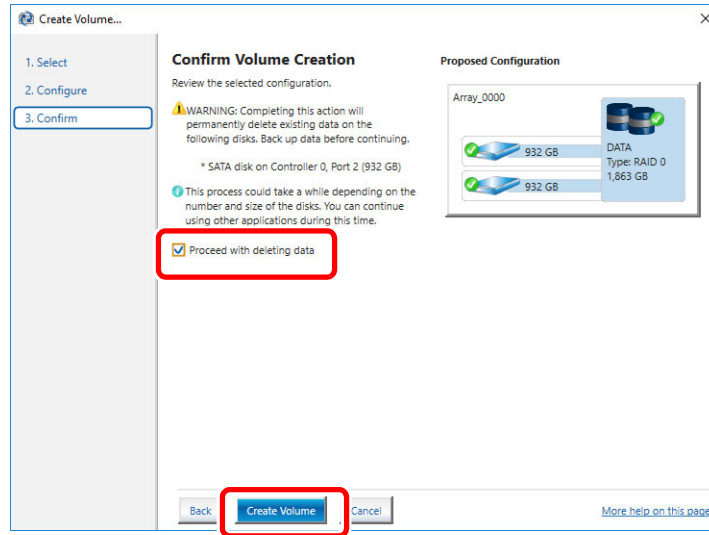

11. Click **OK**.



12. Confirm rebuilding RAID volume has been succeeded.

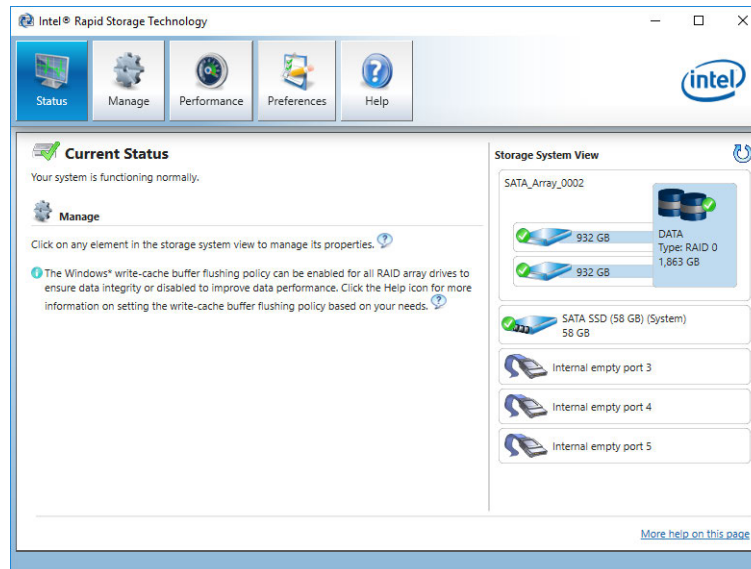

13. Click **Manage**, and then click **Advanced**.

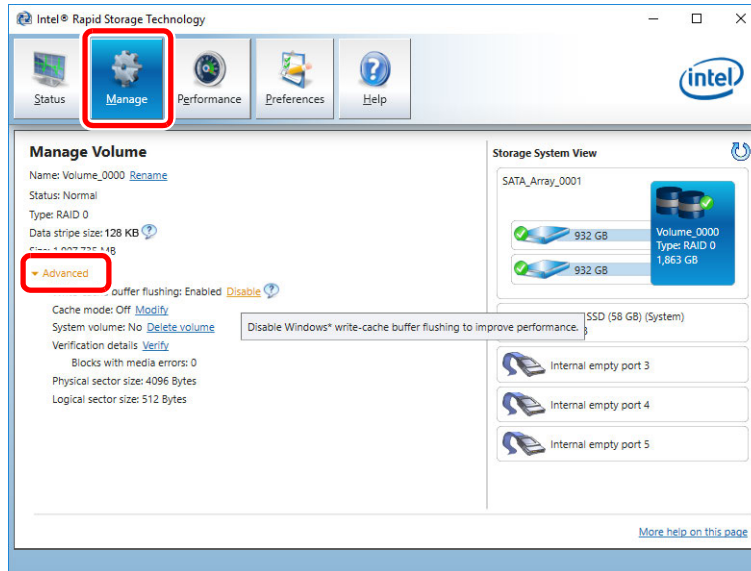

14. Click **Disable**.

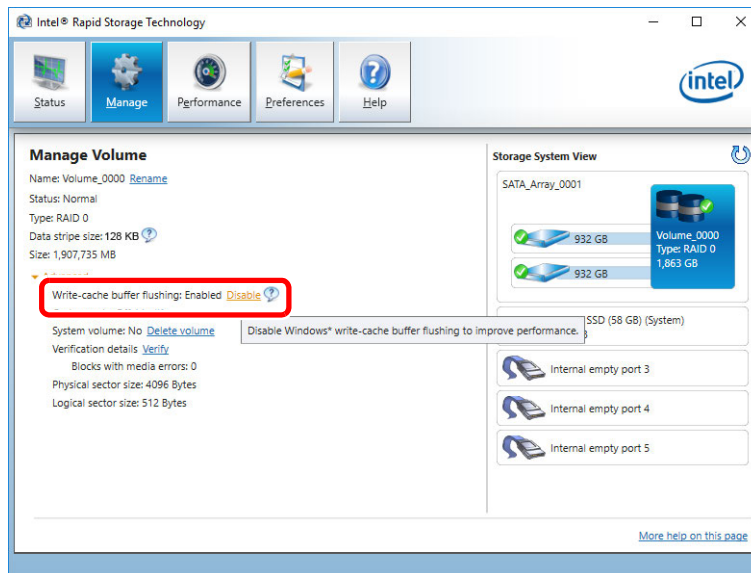

- The status will change to "Write-Cache buffer flushing : Disabled".

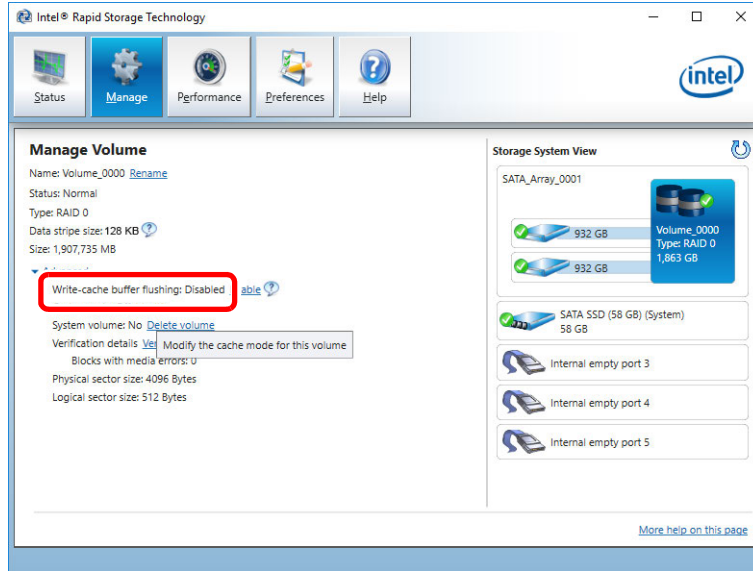

15. Click **Modify**.

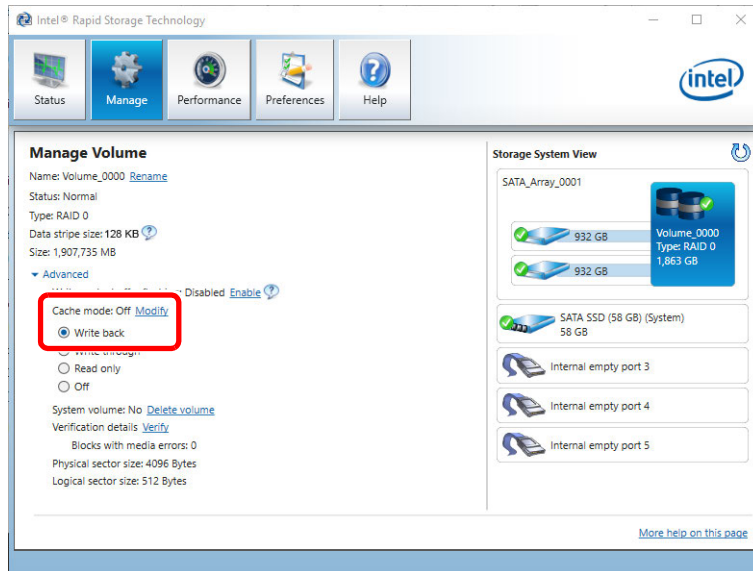

16. Click **Yes**.

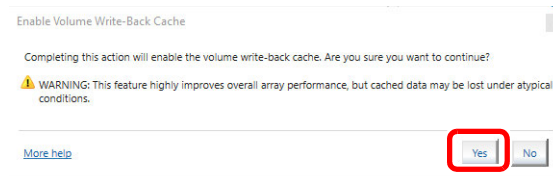

17. Confirm that the status has changed to "Cache mode: Write Back".

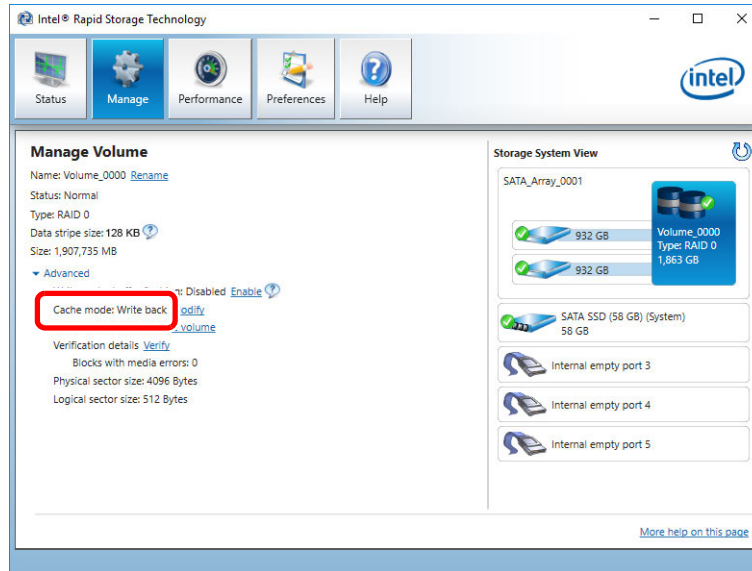

18. If this dialog box appears, click **Cancel**.

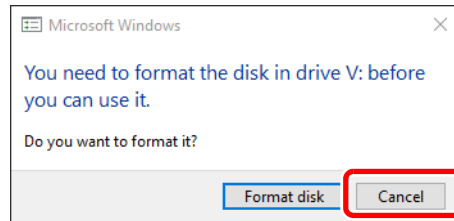

- Rebuilding the RAID is completed. Next, allocate the drive.

19. In the Maintenance Tools main screen, select the **Harddisk** tab, and then click **Disk Management**.

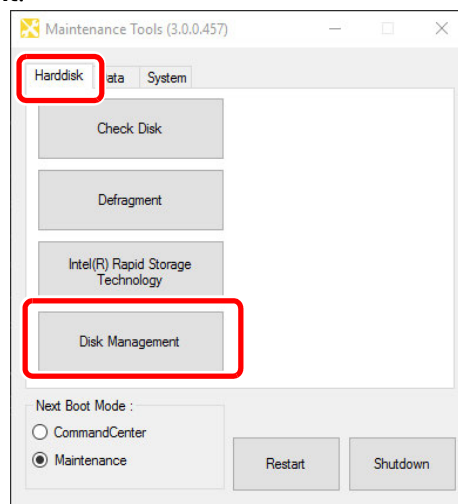

20. Check **Disk 1**, and select **GPT (GUID Partition Table)**, and then click **OK**.

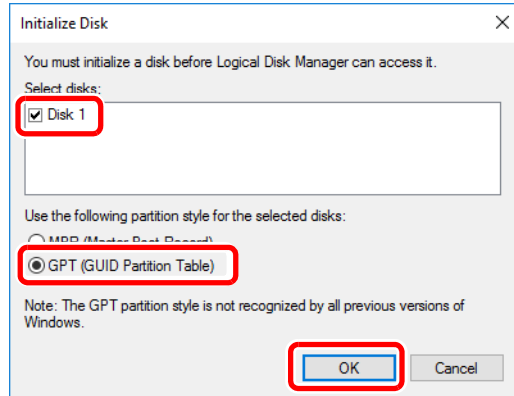

- If the "Initialize Disk" dialog box does not appear, right-click on **Disk 1** then select **Initialize Disk** context menu.

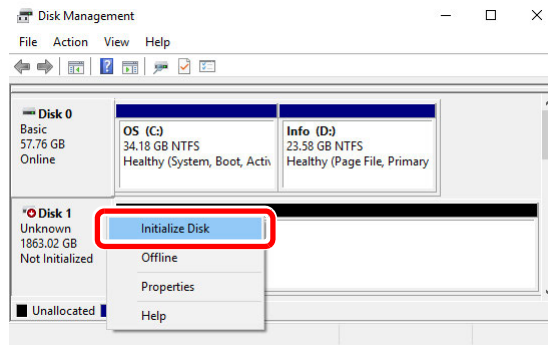

21. Right-click the unallocated space, and select **New Simple Volume...** context menu.

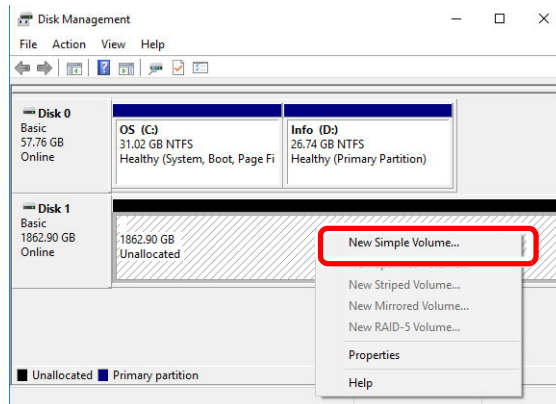

22. Click **Next**.

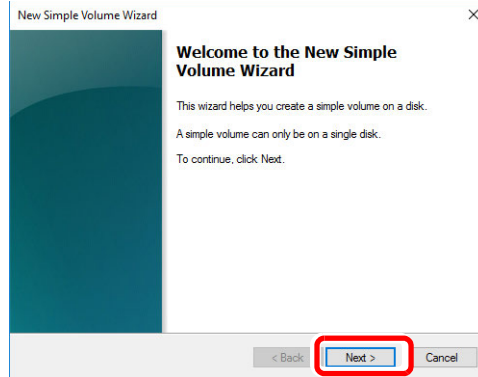

23. Enter the maximum value of the drive space in "Simple volume size in MB:", and enter **Next**.

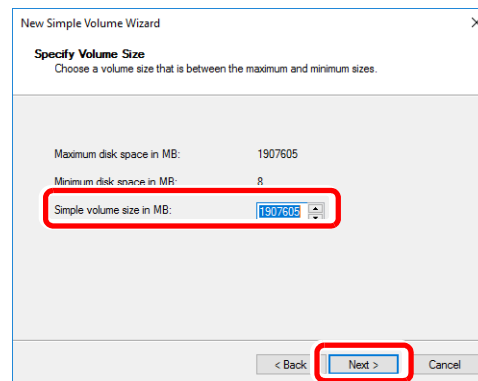

24. Select **Assign the following drive letter:** , and select "V" from the list, and then click **Next**.

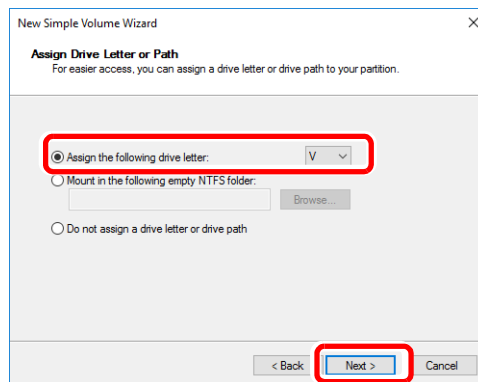

25. Select **Format this volume with the following settings**, and select options as follows.

- Volume label - DATA

- Check **Perform a quick format**.

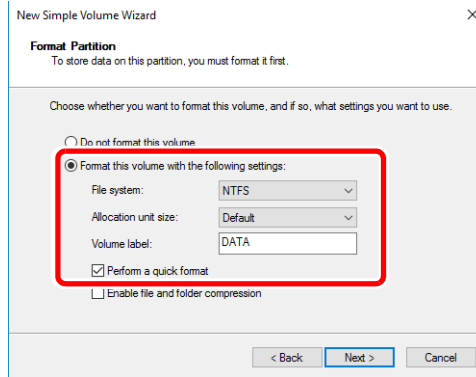

26. Click **Next**.

27. Click **Finish**.

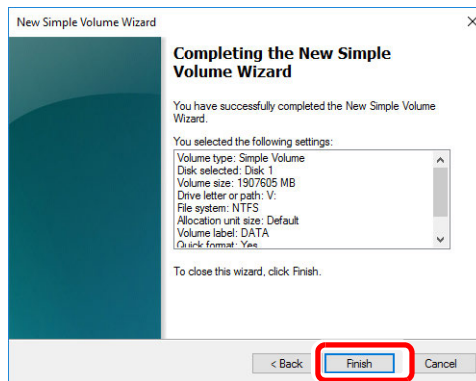

- Once disk format finished, media drive will be online.

Restoring to the factory default condition

Use this procedure to restore the T2 from built-in USB image stick.

⚠ CAUTION: Do not connect any external storage device via USB port, or the media card reader when restoring to the factory default condition.

⚠ CAUTION: A recovery will initialize all of the data below. You should back up your data to an external storage.

- Database
- T2 configuration
- Logs (the operation log, Windows OS internal event log, database log, and crash dumps)

1. Turn on the T2.
2. When the POST screen appears, keep pressing the [F7] key on the keyboard.
 - Boot Menu (Please select boot device:) appears.
3. Select GH PicoDriveL3 PMAP using the [↑] or [↓] key, and then press the [Enter] key.

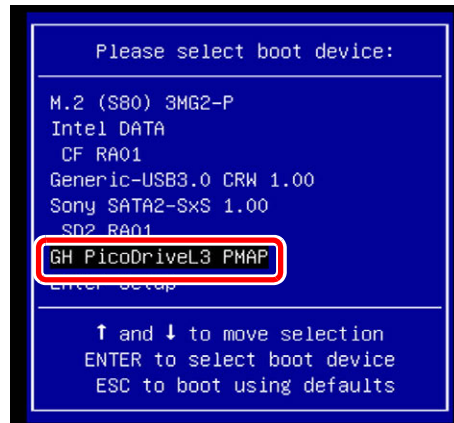

4. On the "TOP" page, select "1. Restore the system to the factory image" then press the [Enter] key.

```
*****
**                               **
**   T2 4K Series Recovery Utility   Rev.001   **
**                               **
*****
Please choose an option below:

[TOP]

1. Restore the system to the factory image
2. Move to <<Advanced page>>
3. Exit program

Enter number (1 to 3) :
```

5. When the message "Are you sure you want to restore?" appears, press the [Y] key, and then [Enter] key.

- Restore process will run. Once restoration finished, T2 will automatically restart.

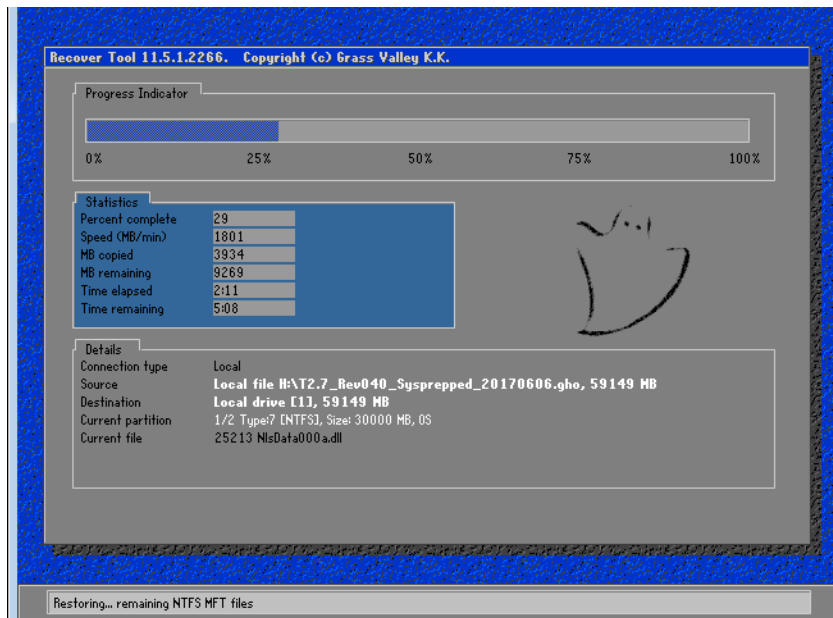

6. T2 will start in the maintenance mode. In the Maintenance Tools main screen, check CommandCenter then click the Restart button.

NOTE: It is recommended to initialize the data after restoring to the default. For detailed instructions, refer to "Initializing the data" on page 28.

Troubleshooting Problems

If you think there is something wrong (broken) with your T2, go through the following preliminary steps:

- ["Step 1: Check configurations" on page 52](#)
- ["Step 2: Check connections and external equipment" on page 52](#)

Then use the following topics to troubleshoot specific problem areas:

- ["Shutdown/restart problems" on page 52](#)
- ["Checking external equipment" on page 53](#)
 - ["PC monitor problems" on page 53](#)
 - ["Keyboard problems" on page 53](#)
 - ["Mouse problems" on page 54](#)
- ["Motherboard/BIOS startup" on page 54](#)
- ["T2 startup" on page 55](#)
- ["Thermal problems" on page 55](#)
- ["Power supply problems" on page 55](#)
 - ["Common to all models" on page 55](#)
 - ["Only T2 4K Elite" on page 56](#)
- ["Front panel problems" on page 56](#)
 - ["LCD touch screen and operation buttons problems" on page 56](#)
 - ["Front USB group unit problems" on page 57](#)
- ["Media card reader problems \(T2 4K Elite only\)" on page 58](#)
- ["Timecode problems" on page 59](#)
- ["Operational problems" on page 59](#)
- ["Storage problems" on page 60](#)
 - ["Media File System problems" on page 60](#)
 - ["Media drive problems" on page 60](#)
 - ["Checking the storage system" on page 61](#)

Step 1: Check configurations

Many times what appears to be a T2 fault is actually an easy-to-fix configuration problem. Refer to the User Manual for operator tips that help you verify basic configuration and correct common record/play problems.

Step 2: Check connections and external equipment

Loose or improperly connected cables are the most likely source of problems for the system, monitor, or other external equipment. A quick check of all the cable connections can easily solve these problems. Refer to the User Manual for help with making connections. Refer to the troubleshooting topic "[Checking external equipment](#)" on page 53 if you suspect a failure in a device connected to the T2.

Shutdown/restart problems

If the T2 is inoperable due to a software error it can effect the operation of the power switch. If pressing the power switch does not shut down the T2, keep pressing the switch for 10 seconds or more for force shutdown. If that does not work, turn off the main power switch on the rear panel and disconnect the power cord.

Checking external equipment

This section provides troubleshooting procedures for external devices that connect to the T2.

PC monitor problems

The BIOS startup screen is displayed with VGA resolution.

Problem	Possible Causes	Corrective Actions
Screen turns on, but nothing from the T2 is displayed.	The monitor ports (DisplayPort/DVI-D) are faulty, or the cable is broken.	Replace the PC monitor cable. Make sure, the PC monitor can display at least SXGA resolution.
	BIOS settings have been tampered with.	Enter the BIOS setting menu. And run "Load Setup Default".
	The T2 system settings have been tampered with.	Restore to factory default from built-in USB stick. Refer to "Restoring to the factory default condition" on page 49 .
The dual monitor cannot be used.	The monitor ports (DisplayPort/DVI-D) cannot be connected simultaneously. (Exclusive use only)	Single monitor should be connected via either DisplayPort or DVI-D.

Keyboard problems

The keyboard is detected during BIOS startup. The USB keyboard is detected with plug-and-play.

Problem	Possible Causes	Corrective Actions
The T2 does not respond correctly to keyboard operation.	<ul style="list-style-type: none"> Failure to detect connected keyboard Keyboard hardware fault Motherboard hardware fault 	<ol style="list-style-type: none"> 1. Disconnect and re-connect the keyboard. If the problem still persists, use another USB port to connect the keyboard. 2. Replace the keyboard. 3. Restore the T2 to factory default. If the problem still persists, replace the motherboard.
	<ul style="list-style-type: none"> Incorrect operation of Plug and Play in the T2 Motherboard hardware fault 	<ul style="list-style-type: none"> • Restore to factory default from the built-in USB stick. Refer to "Restoring to the factory default condition" on page 49. • If restoring to factory default does not resolve the problem, replace the motherboard.

Mouse problems

The mouse is detected during BIOS startup. The USB mouse is detected with plug-and-play.

Problem	Possible Causes	Corrective Actions
The T2 does not respond correctly to mouse operation.	<ul style="list-style-type: none"> • Failure to detect connected mouse • Mouse hardware fault • Motherboard hardware fault 	<ol style="list-style-type: none"> 1. Disconnect and re-connect the mouse. If the problem still persists, use another USB port to connect the mouse. 2. Replace the mouse. 3. Restore the T2 to factory default. If the problem still persists, replace the motherboard.
	<ul style="list-style-type: none"> • Incorrect operation of Plug and Play in the T2 • Motherboard hardware fault 	<ul style="list-style-type: none"> • Restore to factory default from the built-in USB stick. Refer to "Restoring to the factory default condition" on page 49. • If restoring to factory default does not resolve the problem, replace the motherboard.

Motherboard/BIOS startup

A few seconds after power has been turned on, system information message will appear and the BIOS Power On Self Test (POST) runs. During the time, you can enter the BIOS settings by pressing [F2] key several times. Once the BIOS POST succeeded, the Grass Valley logo will appear and Windows operating system start process will run.

If key operation is required during the BIOS POST process, or Windows start up does not run or does not proceed, refer to the followings to identify the problem.

Problem	Possible Causes	Corrective Actions
After the appearance of the Grass Valley logo and during the startup process, "_" appears at the left of the screen and the startup process does not proceed.	Startup device priority might be inverted in the BIOS settings.	Use the following procedure to change the startup device priority. <ol style="list-style-type: none"> 1. During the POST process, press the [F2] key several times. 2. Press the [F9] key to load optimized defaults. 3. Select [Yes] then press the [Enter] key. 4. Press the [F10] key. "Save & reset" screen will appear. 5. Select [Yes] then press the [Enter] key.
After appearing the Grass Valley log and during T2 startup, "Reboot...press a key" appears and the system stops.		

T2 startup

Once the BIOS POST process succeeded, Windows operating system will start. Once the Windows operating system starts correctly, the CommandCenter will start.

If the system does not startup correctly, Restore to factory default from built-in USB stick. Refer to ["Restoring to the factory default condition" on page 49](#).

Thermal problems

 **WARNING:** Be sure to turn off the system and unplug the power cord prior to checking the cabling and connections inside the T2, or removing/replacing any parts. Otherwise, electric shock or product failure may result.

Problem	Possible Causes	Corrective Actions
The fans are noisy or otherwise run erratically. The T2 overheats.	Airflow is blocked.	Ensure adequate airflow around the T2.
	The fan module is not operating correctly.	Inspect the fan module and its connections for proper operation. The fan gets its power from the motherboard, the riser card, or the power supply unit, so make sure they are not faulty as well. If the fans are not operating correctly, replace the fan module as explained in "Removing the front cooling fan" on page 89 , "Removing the mid-cooling fan" on page 86 and "Removing the rear fan" on page 90 .

Power supply problems

 **WARNING:** Be sure to turn off the system and unplug the power cord prior to checking the cabling and connections inside the T2, or removing/replacing any parts of the T2. Otherwise, electric shock or product failure may result.

Common to all models

Problem	Possible Causes	Corrective Actions
The T2 will not power on or power fails while the T2 is in operation.	The power source is faulty.	Make sure your power source is reliable.
	A power cord is faulty.	Replace the power cord.
	The T2 is too hot. The built-in overtemperature protection can shut down the power supply unit.	Cool the T2. Refer to "Thermal problems" on page 55 .
	The power supply unit is faulty. This is indicated if the LCD touch screen and Power LED does not come on.	Replace the power supply unit. Refer to "Removing the power supply unit" on page 96 .

Only T2 4K Elite

Problem	Possible Causes	Corrective Actions
AC IN (power failure detection indicator) blinks in red.	The power cord is faulty.	Both of the power supply units are running. The T2 4K Elite can operate with just one power cord connected. Connect one power cord at a time and test with a replacement cord.
	The power source is faulty.	Make sure your power source is reliable.
	The main power switch has been turned off.	Turn on the main power switches on both power supply units.
Front PSU indicator blinks in red.	The power supply unit is faulty.	Check if AC IN (power failure detection indicator) lights in green. If it lights in green, replace the power supply unit. Refer to "Removing the power supply unit" on page 96.
Front FAN indicator blinks in red.	The fan of the power supply unit is faulty.	Replace the power supply unit. Refer to "Removing the power supply unit" on page 96.

Front panel problems

 **WARNING:** *Be sure to turn off the system and unplug the power cord prior to checking the cabling and connections inside the T2, or removing/replacing any parts of the T2. Otherwise, electric shock or product failure may result.*

LCD touch screen and operation buttons problems

Problem	Possible Causes	Corrective Actions
Nothing is displayed on the LCD touch screen.	<ul style="list-style-type: none"> The power cable to the button kit is disconnected or broken. The LCD touch screen is broken. 	<ol style="list-style-type: none"> Inspect power cable and connection to the button kit and front USB group unit. Try another power socket of the front USB group unit. If the problem persists, replace the LCD touch screen. Refer to "Removing the LCD touch screen" on page 81.

Problem	Possible Causes	Corrective Actions
The LCD touch screen image is faulty.	<ul style="list-style-type: none"> There is a connection failure between the LCD touch screen and the motherboard. 	<ol style="list-style-type: none"> 1. Make sure CommandCenter is up and running. 2. When the LCD touch screen is faulty with the CommandCenter launched, remove the top cover and front panel and, check the button kit cable connections. Refer to "Removing the button kit" on page 84. If the problem persists, replace the button kit.
No response to tapping on the screen.	<ul style="list-style-type: none"> The software or operating system on the T2 has a fault. The LCD touch screen itself is faulty. 	<ol style="list-style-type: none"> 3. If the problem persists, connect a mouse, keyboard, and PC monitor to the T2 and test functionality. Compare this functionality to that of the LCD touch screen. If everything works fine with the PC monitor but not the front panel, there could be a software problem on the LCD touch screen. Restore the T2 system. Refer to "Restoring to the factory default condition" on page 49. 4. If after system install the LCD touch screen still does not operate, replace the LCD touch screen. Refer to "Removing the LCD touch screen" on page 81.
The Jog/Shuttle knob operates poorly or not at all.	The Jog/Shuttle knob is bent or broken.	Inspect the Jog/Shuttle knob to confirm that there is a mechanical problem with the knob. If so, replace the Jog/Shuttle knob. Refer to "Removing the Jog/Shuttle knob" on page 77 .
The operation buttons are not working.	<ul style="list-style-type: none"> The operation buttons or front board are broken. The software or operating system on the T2 has a fault. 	<ol style="list-style-type: none"> 1. Make sure CommandCenter is up and running. 2. When the operation buttons do not operate with CommandCenter launched, make sure the button kit device is present. Enter the maintenance mode. Open the device manager. And confirm "HID-compliant game controller" is present under the "Human Interface Devices" category. If not present, inspect the cable and connections. If the problem persists, replace the button kit. Refer to "Removing the button kit" on page 84. 3. Restore to factory default from built-in USB stick. Refer to "Restoring to the factory default condition" on page 49.

Front USB group unit problems

Problem	Possible Causes	Corrective Actions
The front headphone jack or volume control does not operate properly.	The cable to the front USB group unit is disconnected or faulty.	Make sure that the front USB group unit and cables are connected properly and there is no sign of physical damage. Restart the T2. If the problem persists, replace the front USB group unit. Refer to "Removing the front USB group unit" on page 77 .
	The front USB group unit is faulty.	Replace the front USB group unit. Refer to "Removing the front USB group unit" on page 77 .

Problem	Possible Causes	Corrective Actions
The power switch and/or power indicator LED do not work.	The cable to the motherboard is disconnected or faulty.	Make sure that the motherboard and cables are connected properly and there is no sign of physical damage. Restart the T2. If the problem persists, refer to "Motherboard/BIOS startup" on page 54.
	The power supply unit is faulty.	Refer to "Power supply problems" on page 55.
	The front USB group unit is faulty.	Replace the front USB group unit. Refer to "Removing the front USB group unit" on page 77.
The front USB port does not connect properly.	The cable to the motherboard is disconnected or faulty.	Make sure that the motherboard and cables are connected properly and there is no sign of physical damage. Restart the T2. If the problem persists, refer to "Motherboard/BIOS startup" on page 54.
	The front USB group unit is faulty.	Replace the front USB group unit. Refer to "Removing the front USB group unit" on page 77.

Media card reader problems (T2 4K Elite only)

 **WARNING:** Be sure to turn off the system and unplug the power cord prior to checking the cabling and connections inside the T2, or removing/replacing any parts of the T2. Otherwise, electric shock or product failure may result.

Problem	Possible Causes	Corrective Actions
Inaccessible to inserted media card. This can be accompanied by an error message from the Windows operating system.	There is a problem with the media currently inserted in the media card reader, or the card reader itself is faulty.	<ol style="list-style-type: none"> 1. Remove and re-insert the medium and confirm if the access indicator is lit. 2. Try another media. 3. If the problem persists, inspect the connection of media card reader USB and power cable, as well as physical damage. 4. If the problem persists, replace the Media Card Reader Assy as described in "Removing the media card reader assy (T2 4K Elite only)" on page 74.

Timecode problems

Refer to the User Manual for more details of corrective actions.

Problem	Possible Causes	Corrective Actions
Recorded timecode reads --:--:--;--.	No timecode source for the channel.	Set the timecode source.
A clip shows no mark-in/ mark-out timecode, the current timecode display shows --:--:--;--., or the last valid timecode is displayed.	The selected timecode source was missing or intermittent during recording.	Check that you have the right R1 channel timecode source selected, verify that timecode is present in the source, and record the clip again. You can also stripe the timecode on an existing clip.

Operational problems

Refer to the User Manual for more details of corrective actions.

Problem	Possible Causes	Corrective Actions
A clip does not play, even though similar clips play on the same channel.	The clip does not match current channel settings or the clip is corrupt.	If the clip appears grayed-out it means it does not match current channel settings. Check the clip properties and verify they are correct for the video standard, and other current settings. Compare properties with those of a clip that plays correctly. If properties are correct the clip is corrupt. Delete and re-record the clip.
A clip can not be edited.	The clip is locked.	Unlock the clip.
Cannot load and play a list.	The playlist does not match current channel settings or the playlist is corrupt.	If the playlist appears grayed-out it means it does not match current channel settings. Check the video standard in the property of the source clip for each event in the playlist. Compare properties with those of a playlist that plays correctly. If properties are correct the playlist is corrupt. Delete and re-make the playlist.
Cannot operate a channel from the local T2. Controls are disabled.	The channel and the channel's control mode is set to Remote.	Disable remote mode. Or alternatively, enable local operations while being remote controlled.
A video cannot be recorded.	R1 channel is configured for incorrect video standard.	Check the current setting of R1 channel for video standard. Verify that the video input signal is the correct standard.

Storage problems

If you suspect problems with your T2's storage system, read the following sections.

Media File System problems

Problem	Possible Causes	Corrective Actions
Recording and/or playback are not working correctly.	<ol style="list-style-type: none"> 1. Corrupting media file. 2. Inconsistency exists between the database and media file. 3. The RAID volume is faulty. 	<ol style="list-style-type: none"> 1. If the problem occurs on a specific clip, confirm if the same problem occurs on another clip. If the problem only occurs on the specific clip, delete it. For recording problems, make sure the video source is reliable then re-record a video. 2. Run the database consistency check in the Maintenance Tools. Refer to "Checking the data consistency" on page 26. 3. Check the RAID volume status. Refer to "Media drive RAID volume maintenance" on page 36.

Media drive problems

To check the media drives quickly, open **My Computer** from the **Start** menu, and check C:, D:, and V: drives.

 **WARNING:** *Be sure to turn off the system and unplug the power cord prior to checking the cabling and connections inside the T2, or removing/replacing any parts of the T2. Otherwise, electric shock or product failure may result.*

Problem	Possible Causes	Corrective Actions
Startup fails and "Operating System not found" appears.	System SSD is faulty.	Check if the system SSD is properly installed to the M.2 slot on the motherboard. If it is properly installed, the system SSD may be hardware fault. Replace the system SSD. Refer to "Removing system SSD" on page 71.
The message "Media disks getting full..." appears.	The media drives are reaching maximum capacity.	Delete unused clips and empty the Recycled Bin to get free space on the media drive.

Problem	Possible Causes	Corrective Actions
"Degraded" or "Failed" appears in "Status" on the BIOS screen during T2 startup.	RAID system has some problem.	Delete and rebuild the RAID volume. If the problem persists, replace the faulty disk. Refer to "Media drive RAID volume maintenance" on page 36.

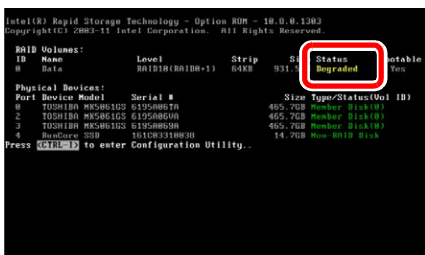

The T2 starts up in the maintenance mode even when starting up in the CommandCenter mode.

Checking the storage system

Use this section if you have problems with video input and/or output that are intermittent or seem to be related to certain usage patterns.

Problem	Possible Causes	Corrective Actions
Symptoms can include the recording stop or black video at playout, frozen video, slow performance, or inconsistent media access.	<p>The following causes can occur on their own or in combination to produce the problem:</p> <ul style="list-style-type: none"> • Disk oversubscription - This occurs when requests to the media drive exceed the disk's bandwidth capabilities. This generally occur in extreme cases when a combination of high-bandwidth operations are taking place, such as Jog/Shuttle, record/play on multiple channels. • High CPU activity in Windows - This occurs when activities on the Windows operating system over-tax the capabilities of the motherboard processor. This commonly happens when unsupported software has been installed that competes with the T2 applications. Virus scanners and screen savers can cause this type of problem, since they can start automatically and consume system resources. • Disk faults - This occurs when a media drive is severely fragmented or has a bad blocks that interfere with some, but not all, media operations. For example, a particular clip can be written on a bad block, so the problem occurs only on that clip. 	<ol style="list-style-type: none"> 1. If unsupported software installed, uninstall them. 2. If the problem persists, reproduce the problem. Identify all the interactions that affected the system and run all the same operations as when the error occurred. Investigate the functions that seem to push the system into the error state. If you determine that certain simultaneous operations cause the problem, change the workflow to avoid those situations. If you determine that the problem is only on certain clips, investigate disk faults. 3. Refer to "Defragmentation of media drive" on page 24 to perform defragmentation of the media drive. If the problem is not solved after defragmentation, refer to "Media drive RAID volume maintenance" on page 36 to rebuild the RAID and format the disk.

Removing and replacing FRUs

This chapter consists of the following:

- "Precautions before operations" on page 64
 - "Required tools" on page 64
 - "Turning off the T2 and disconnecting the power cord" on page 64
- "Removing the top cover (rear)" on page 66
- "Removing the top cover (front)" on page 67
- "Removing data HDD/SSD" on page 69
 - "Data HDD/SSD SATA cable connection" on page 70
- "Removing system SSD" on page 71
- "Removing the power supply status LED board (T2 4K Elite only)" on page 72
- "Removing the media card reader assy (T2 4K Elite only)" on page 74
- "Removing the front panel" on page 76
- "Removing the Jog/Shuttle knob" on page 77
- "Removing the front USB group unit" on page 77
- "Removing the system USB stick" on page 80
- "Removing the LCD touch screen" on page 81
- "Removing the button kit" on page 84
- "Removing RAM module" on page 85
- "Removing the mid-cooling fan" on page 86
- "Removing the front cooling fan" on page 89
- "Removing the rear fan" on page 90
- "Removing LTC/Monitor audio interface board" on page 91
- "Removing the video I/O board" on page 93
- "Removing the remote interface board" on page 94
- "Removing VGA card" on page 95
- "Removing the power supply unit" on page 96
- "Removing the power supply unit enclosure" on page 97

Precautions before operations

FRUs (Field Replaceable Units) are components or parts that can be replaced while making repairs. If failure occurs in your T2 and the failed part is included in any FRU, you can repair it by replacing the FRU without disturbing other components in the system.

This chapter mainly describes removal procedures of FRUs. Unless otherwise documented, installation procedures will be in reverse order of removals. If any installation instructions are documented, be sure to follow them.

The procedures described in this chapter are examples for T2 4K Elite, which also applies to other models unless otherwise mentioned.

For the list of replaceable FRUs and location of each FRU, refer to ["FRU locations" on page 15](#).

NOTE: *Only Grass Valley products and components are supported. Do not install any non-Grass Valley parts.*

NOTE: *Do not discard any of the removed parts such as screws or stays.*

 **WARNING:** *Be sure to turn off the system and disconnect the power cord from the product body prior to removing or replacing any parts of T2. Otherwise, electric shock or product failure may result.*

 **WARNING:** *When you attach parts of T2, be sure to use exactly the same screws as were originally used on the parts.*

 **WARNING:** *Part of T2 may be damaged by electrostatic discharge or physical impacts. When you work on your system, be sure to wear a wrist strap for preventing electrostatic discharge (ESD) and provide grounding.*

Required tools

Phillips screwdriver #1, nippers

Turning off the T2 and disconnecting the power cord

You must always turn off your T2 and disconnect the power cord from the product body prior to removing or replacing FRUs (Field Replaceable Units).

 **CAUTION:** *Be sure to shut down T2 with a proper procedure prior to turning off the system. For instructions on how to shut down the system from the maintenance mode, refer to ["Exiting the maintenance mode to shut down" on page 21](#). For instructions on how to shut down the system from the CommandCenter mode, refer to [User Manual](#).*

1. Turn off the main power switch.

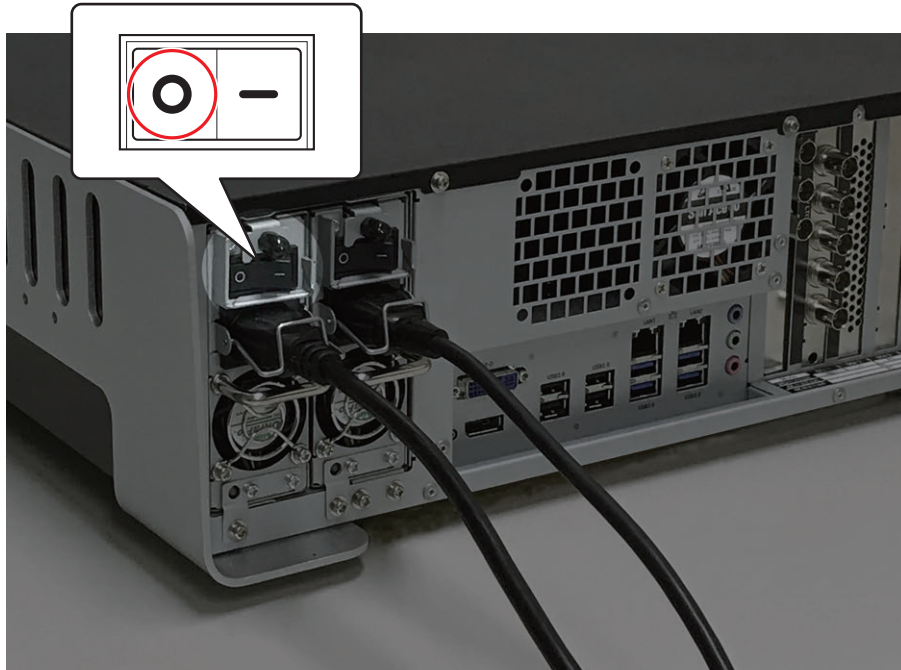

2. Push the power cable clamp (a) to unlock the power cord.

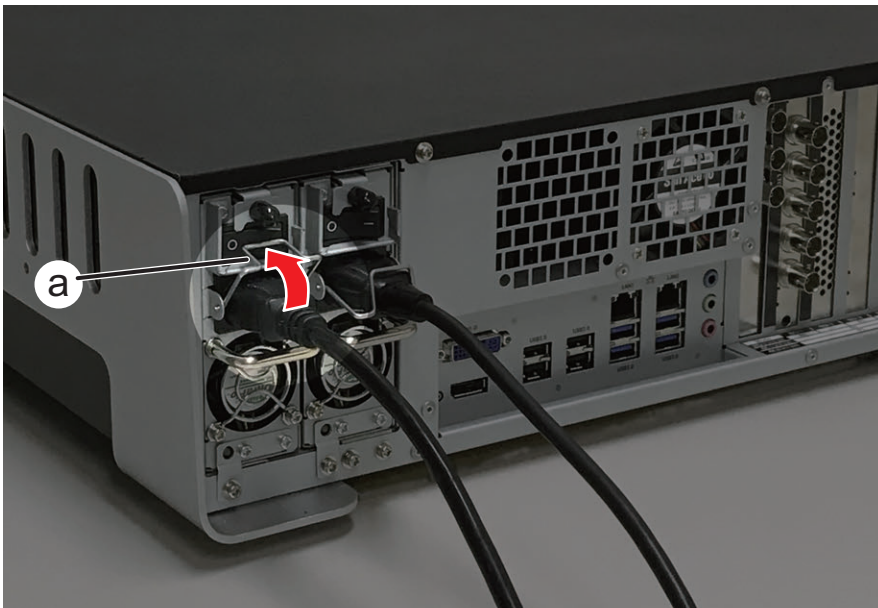

3. Unplug the power cord from the AC inlet.



4. Perform steps 1 to 3 on the other power supply. (T2 4K Elite only)

Removing the top cover (rear)

1. Remove the top cover (rear).
 - (1) Remove 2 screws (with springs and large washers) on the rear side.
 - (2) Hold the top cover (rear) with both hands to slide it out.
 - (3) Remove the top cover (rear).

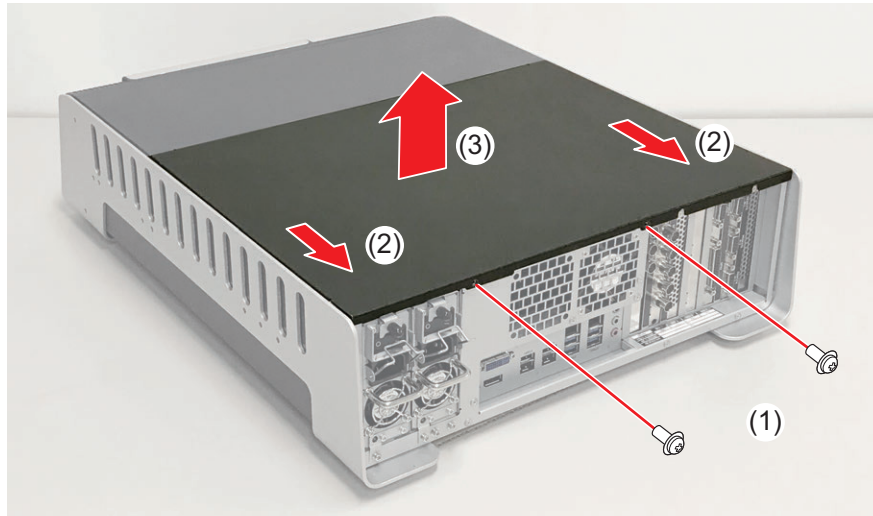

NOTE: To install the top cover (rear), place it at the position in the following figure, and then slide it with both hands.

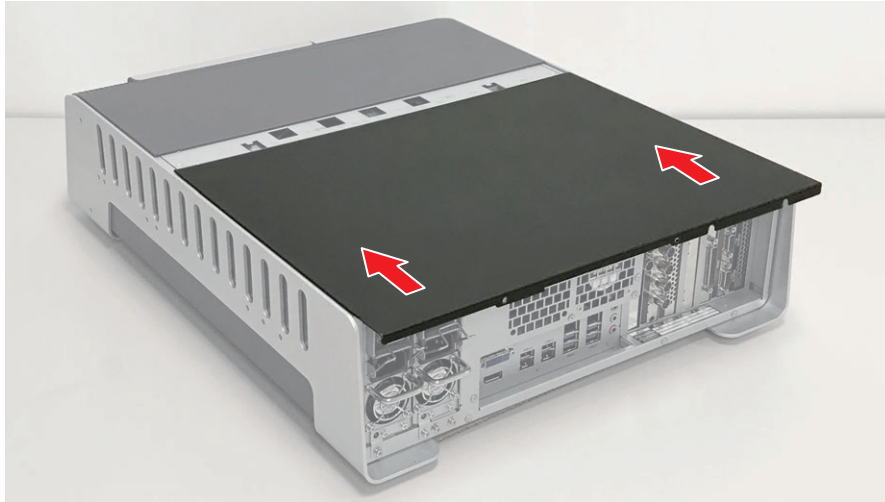

Removing the top cover (front)

1. Removing the top cover (rear). (→P66)
2. Hold the top cover (front) with both hands to slide it out.



3. Remove the top cover (front).



NOTE: To install the top cover (front), hold its both ends with both hands to slide it.

Removing data HDD/SSD

This section describes the procedure to remove data HDD/SSD. T2 4K Elite has two SSD. T2 4K Pro and T2 4K Express have two HDD.

1. Removing the top cover (rear). (→P66)
2. Remove the drive.
 - (1) Confirm the drive number and remove the two screws (with springs and small washers).
 - The drive numbers are “1” and “2” from the top. The following figure shows an example of HDD of drive number “2” to illustrate the common procedure for all HDD.
 - (2) Slide out the drive.

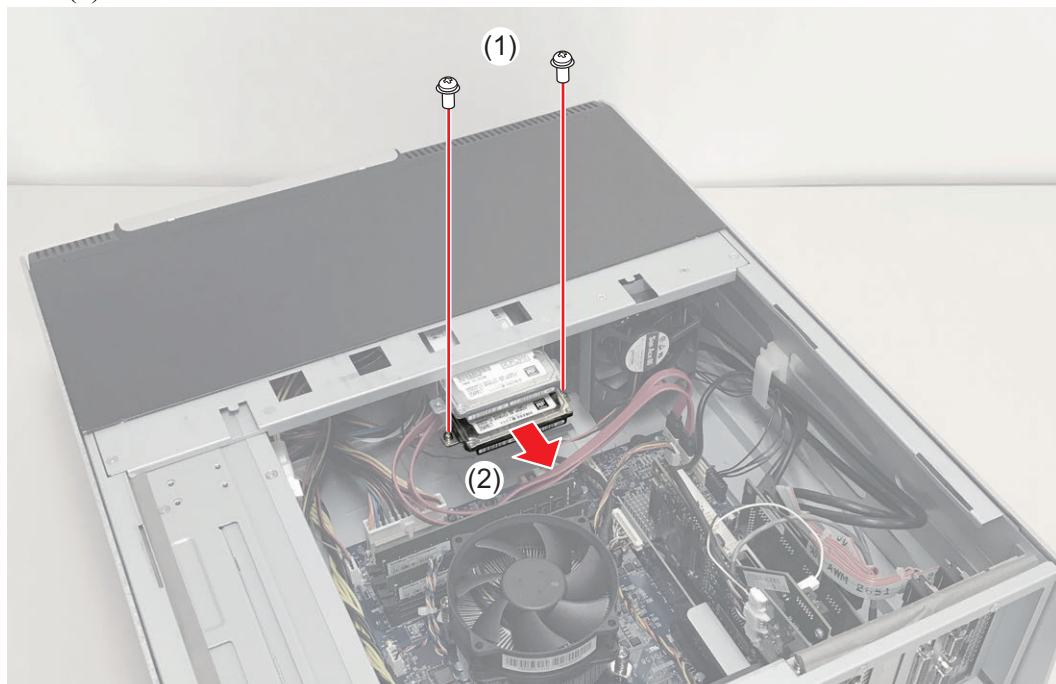

3. Remove the drive from the mount frame.
 - (1) Remove four round screws.
 - (2) Remove the drive from the mount frame.

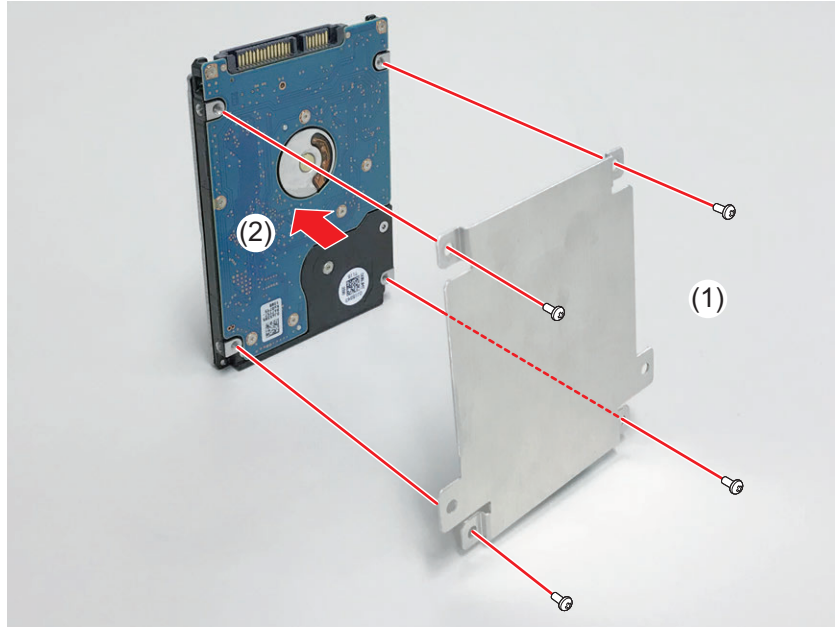

Data HDD/SSD SATA cable connection

They are connected as in the figure below.

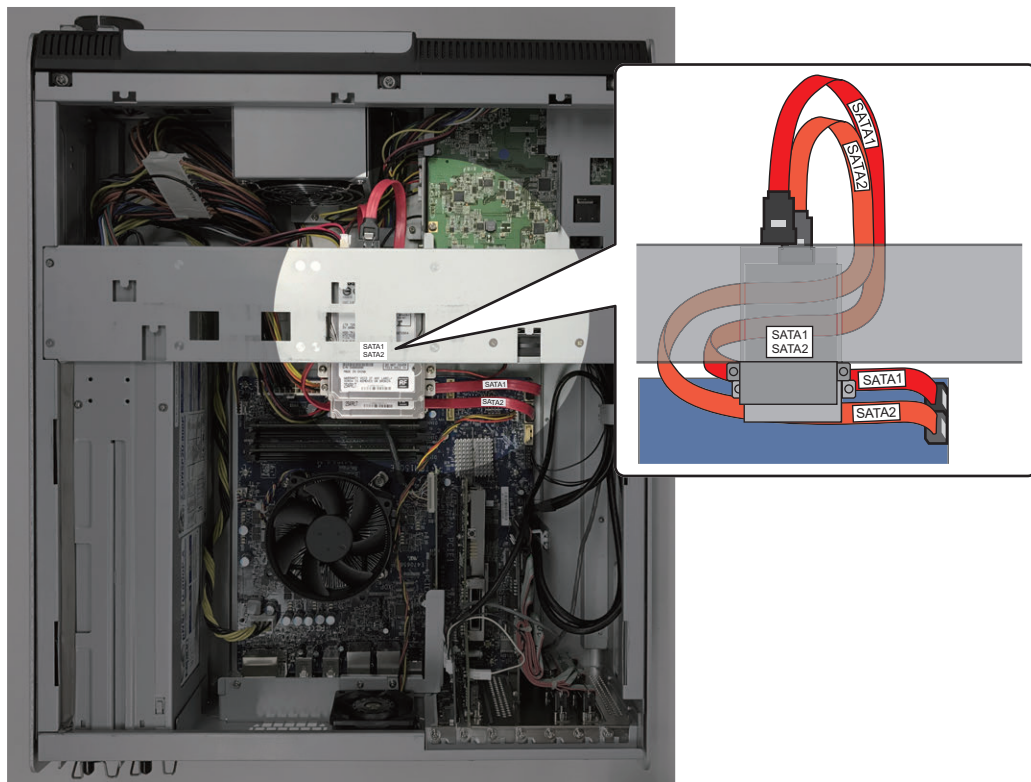

Removing system SSD

1. Removing the video I/O board. (→P93)
2. Remove the system SSD.
 - (1) Remove the screw (1) shown in the following figure.
 - (2) Remove the system SSD.

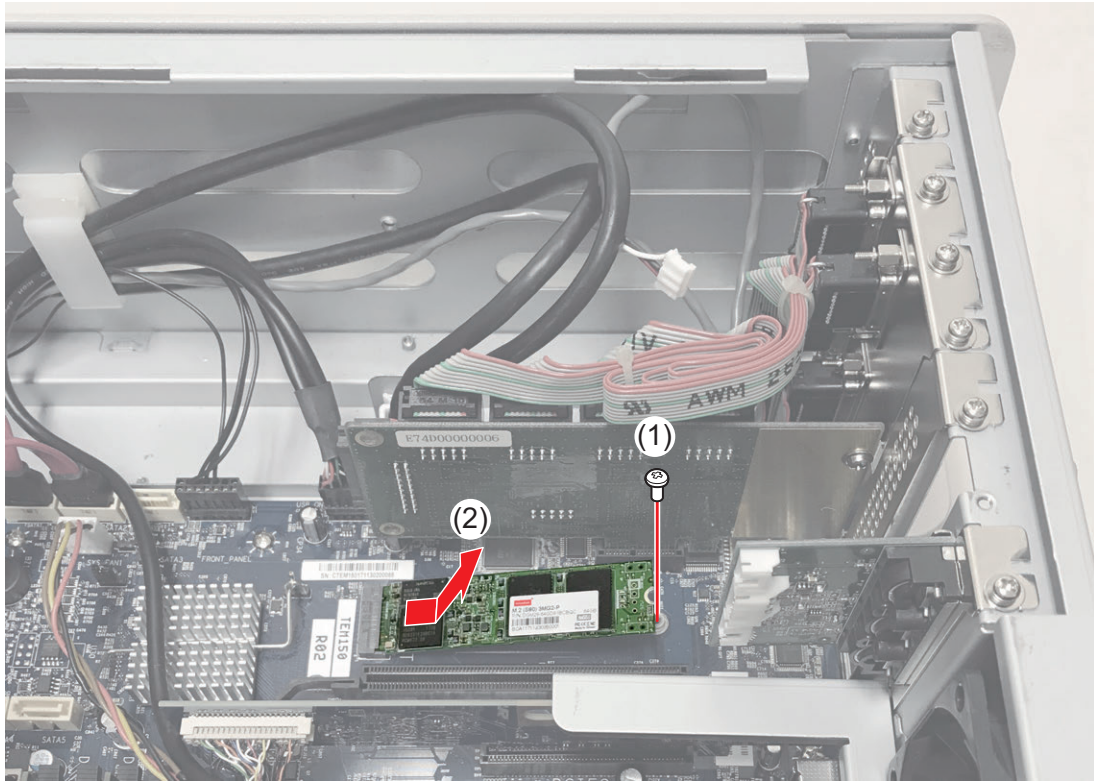

NOTE: To install the system SSD, make sure that the front and back sides are correct. The labeled face comes to the front.

Removing the power supply status LED board (T2 4K Elite only)

1. Perform the procedure for "[Removing the mid-cooling fan](#)" on page 86 up to step 3.
2. Remove the power supply status LED board.
 - (1) Unlock the cable clamber and disconnect the power supply status signal cable.
 - (2) Remove two screws (with springs and small washers).
 - (3) Remove the power supply status LED board.

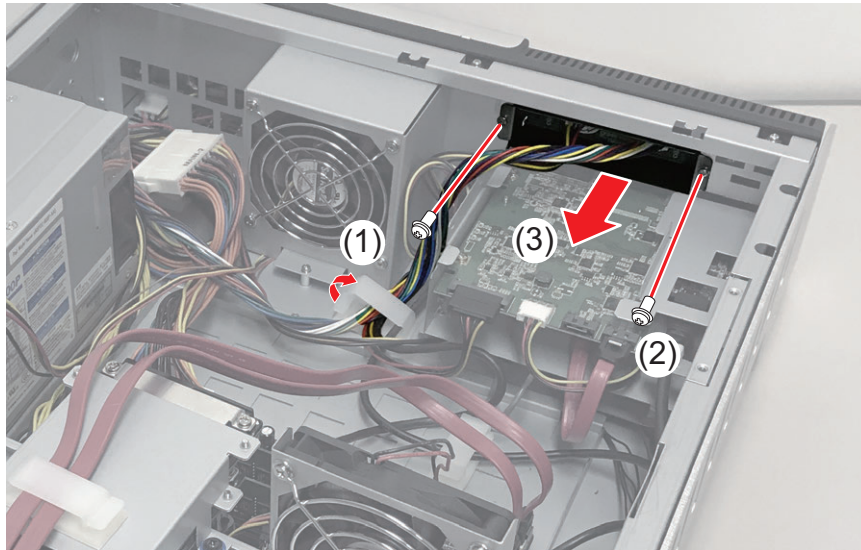

3. Remove two screws (with external toothed washers), and then remove the power supply status LED board from the stay.

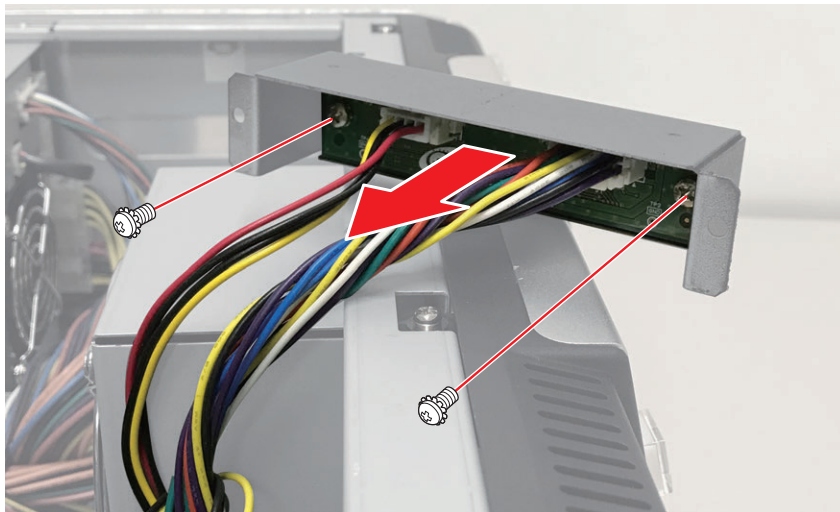

4. Disconnect the cables from the power supply status LED board.
 - (1) Disconnect the power supply status signal cable.
 - (2) Disconnect the power supply status LED board power supply cable.

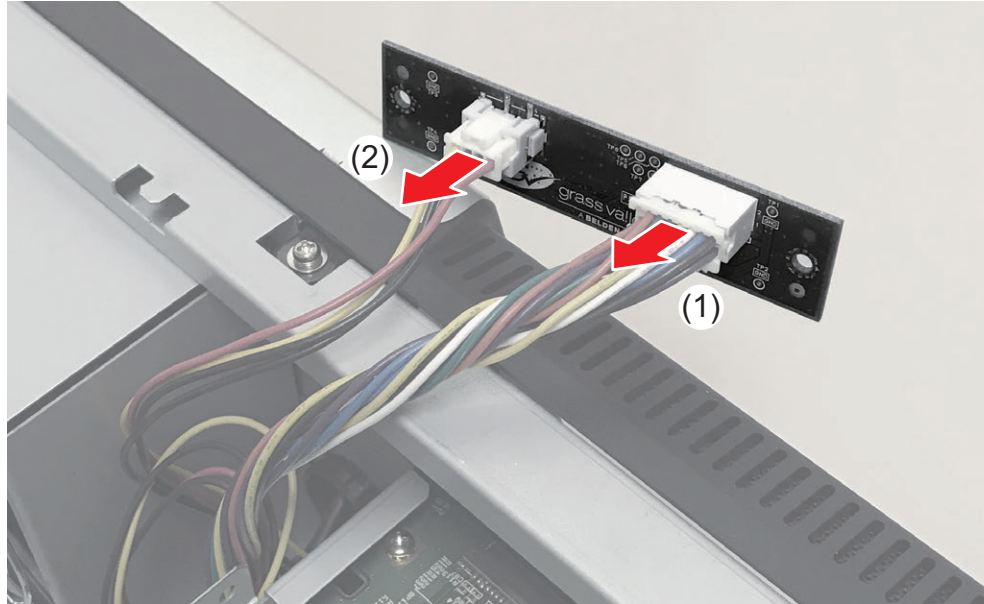

NOTE: To install the power supply status LED board, make sure that the upper and lower sides are correct. The GV logo on the circuit board comes under the cable.

Removing the media card reader assy (T2 4K Elite only)

1. Perform the procedure for "[Removing the mid-cooling fan](#)" on page 86 up to step 3.
2. Remove the media card reader.
 - (1) Unlock the cable clamber and disconnect the USB 3.0 cable.
 - (2) Disconnect the power cable.
 - (3) Remove three screws (with springs and small washers).
 - (4) Remove the media card reader.

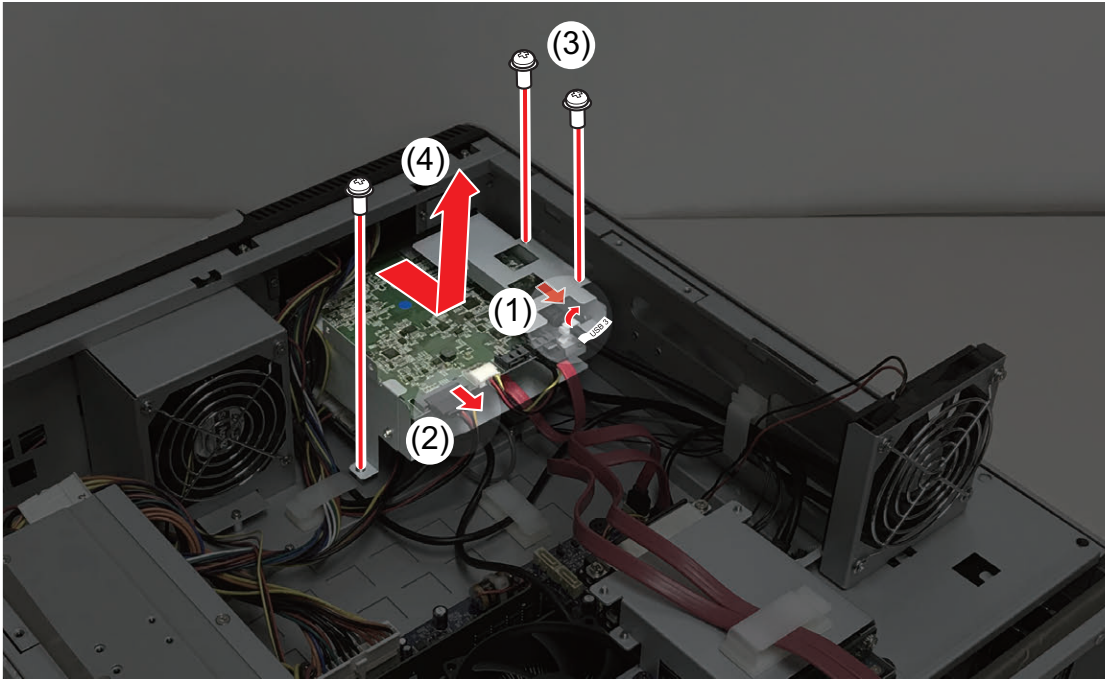

3. Remove the stay from the media card reader.
 - (1) Remove four screws (with springs and small washers).
 - (2) Remove the stay from the media card reader.

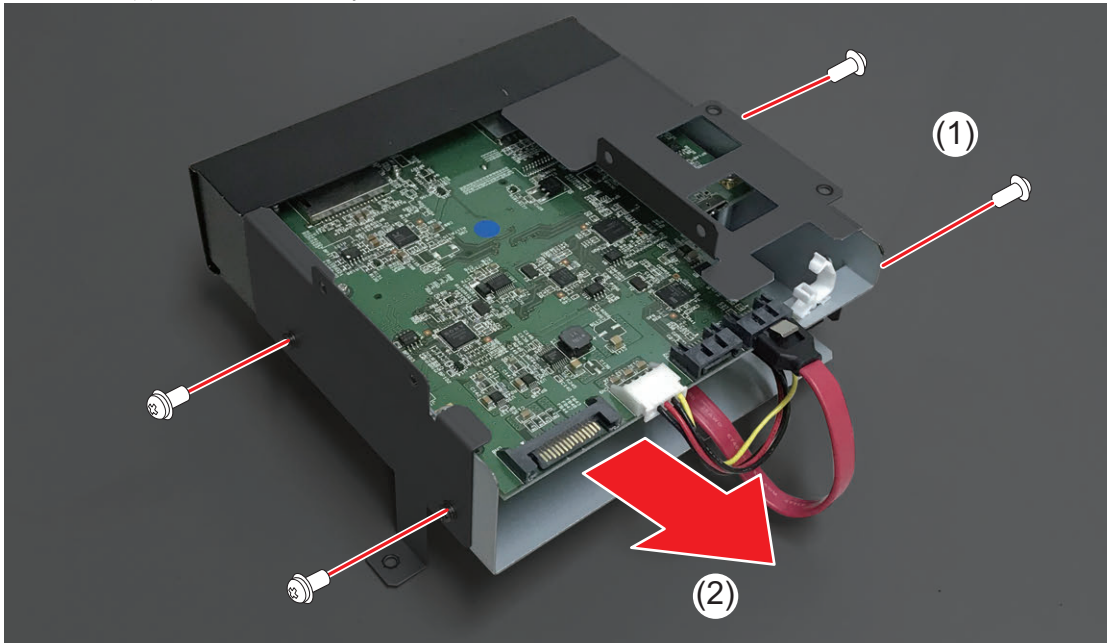

Removing the front panel

1. Removing the top cover (front). (→P67)
2. Remove the front panel.
 - (1) Remove the Jog/Shuttle knob.
 - (2) Remove three screws (with black washers) on the top side of the front panel.
 - (3) Remove two screws (black) on the bottom side of the front panel.
 - (4) Keep the front panel straight up and remove it.

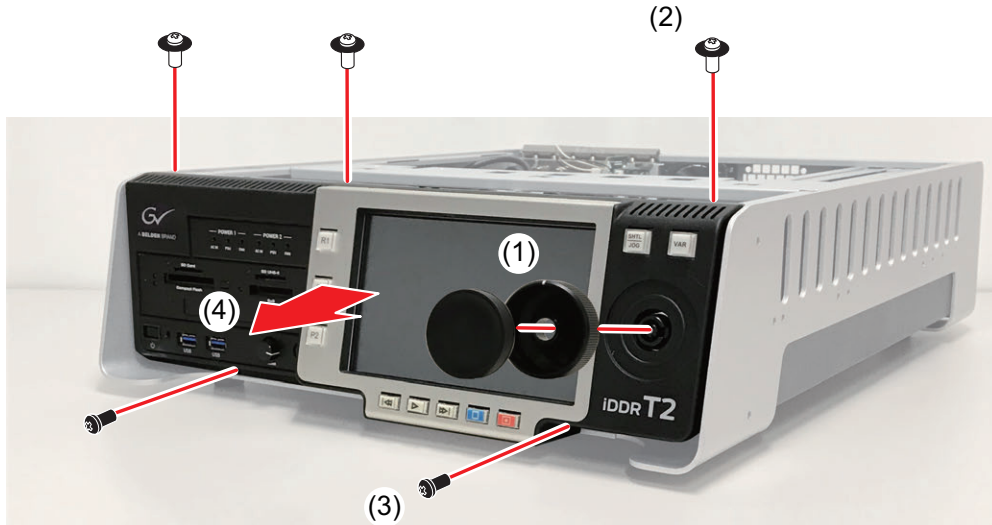

NOTE: To install the front panel, insert it between the two sheets (a) and (b).

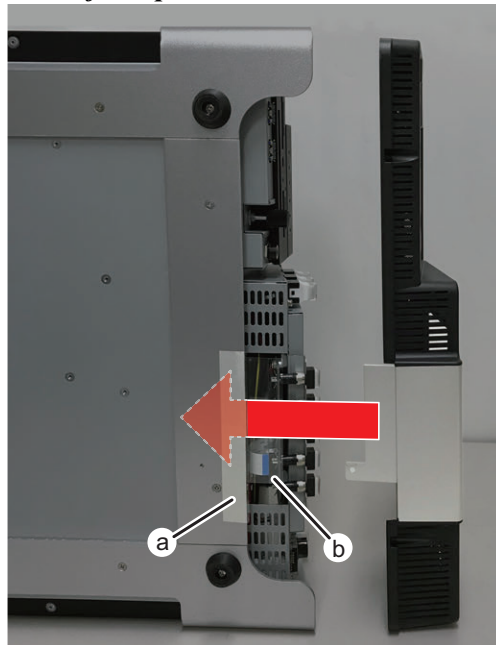

NOTE: To attach the Jog/Shuttle knob, make sure that the parts (a) are aligned.

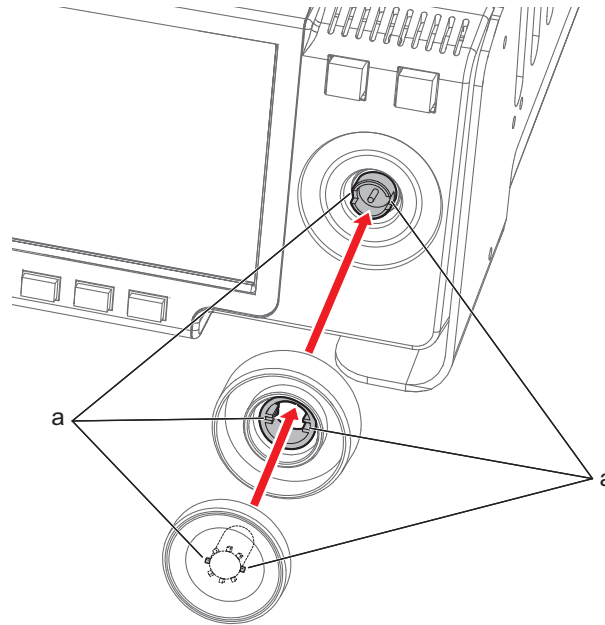

Removing the Jog/Shuttle knob

For instructions on how to remove the Jog/Shuttle knob, refer to ["Removing the front panel" on page 76](#).

Removing the front USB group unit

1. Removing the front panel. ([→P76](#))
2. Perform the procedure for ["Removing the media card reader assy \(T2 4K Elite only\)" on page 74](#) up to step 2.

3. Disconnect the cables.

- (1) Disconnect the power cable of the media card reader.
- (2) Disconnect the power supply status LED board power supply cable.
- (3) Disconnect the power cable of the LCD touch screen.
- (4) Disconnect the peripheral power supply cable.

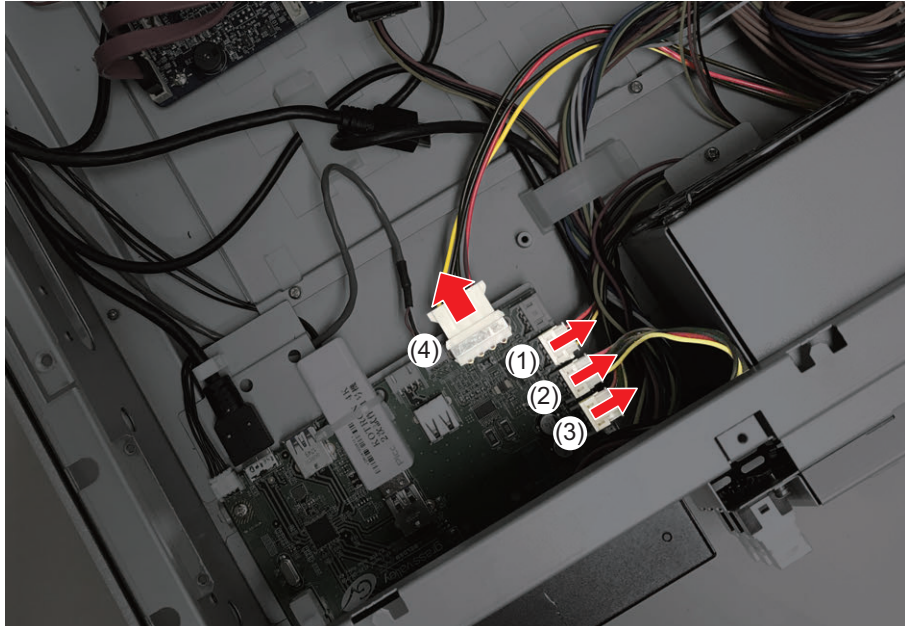

4. Remove the front USB group unit.

- (1) Remove the screw (with spring and small washer) on the front side of the front USB group unit.
- (2) Slide out the front USB group unit.

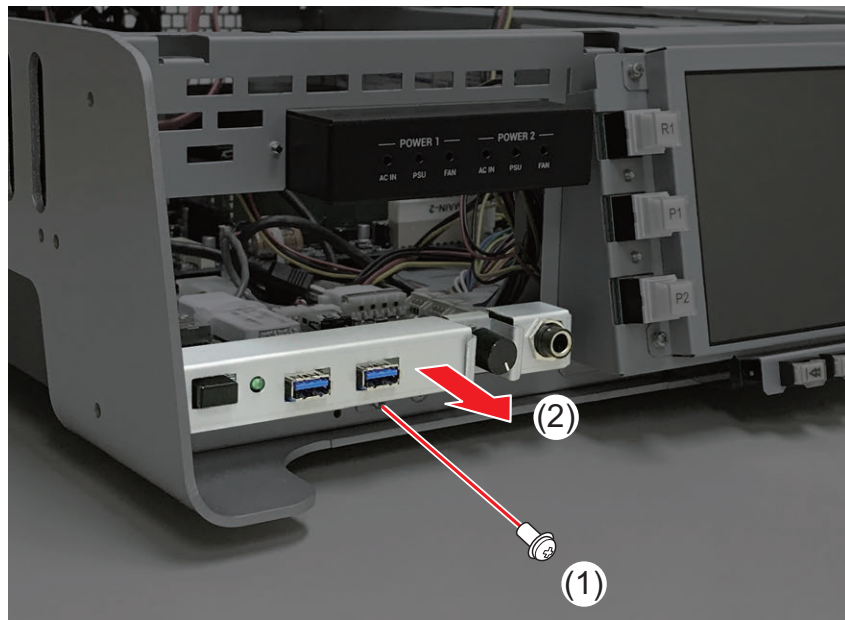

5. Disconnect the cables.

- (1) Disconnect the power switch cable.
- (2) Unlock the cable clamber and disconnect the USB 3.0 cable.
- (3) Disconnect the audio cable.
- (4) Cut the cable tie with nippers and remove the system USB stick.

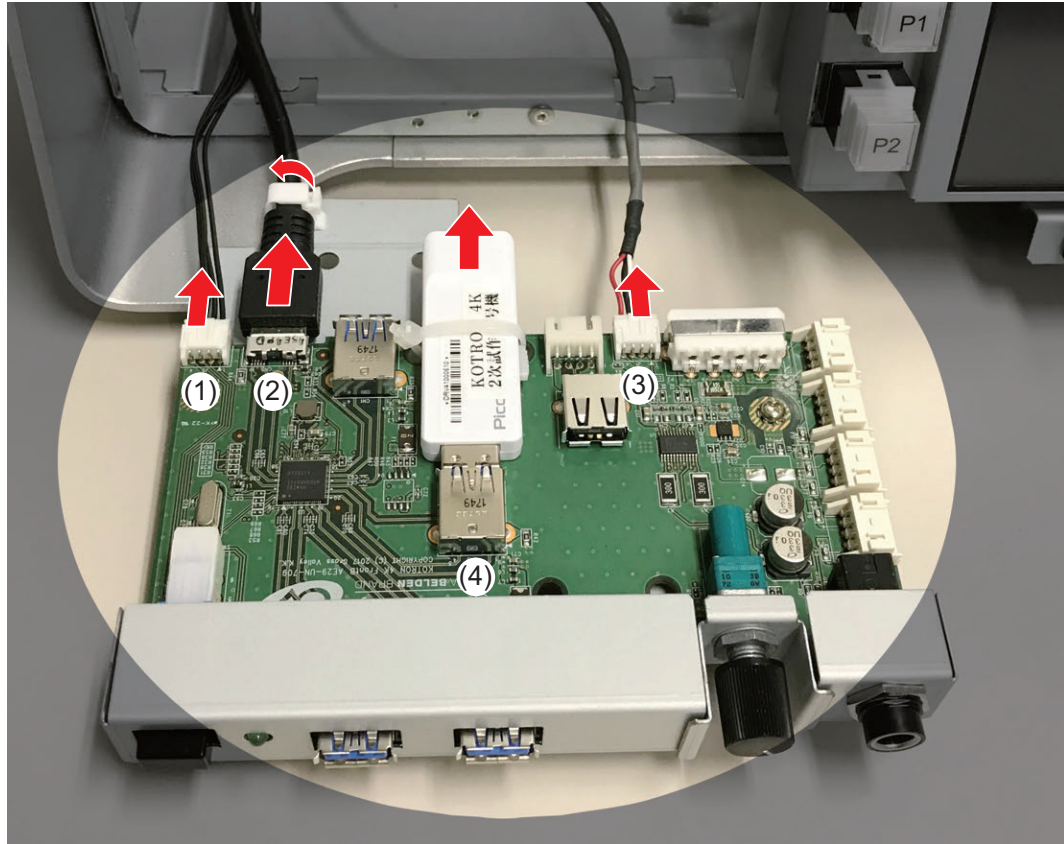

NOTE: To install the system USB stick, thread the cable tie into the slit on the circuit board, attach the system USB stick, and then tighten the cable tie to secure the system USB stick.

Removing the system USB stick

1. Perform the procedure for "[Removing the media card reader assy \(T2 4K Elite only\)](#)" on page 74 up to step 2.
2. Cut the cable tie with nippers and remove the system USB stick.

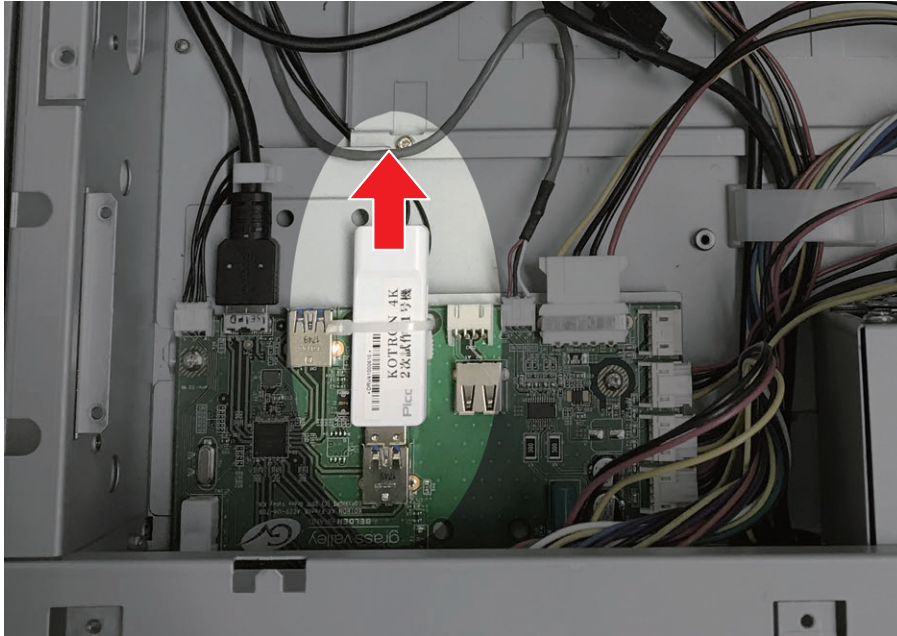

NOTE: To install the system USB stick, thread the cable tie into the slit on the circuit board, attach the system USB stick, and then tighten the cable tie to secure the system USB stick.

Removing the LCD touch screen

1. Removing the front panel. (→P76)
2. Remove the LCD touch screen.
 - (1) Remove two screws (with springs and small washers).
 - (2) Lift up the LCD touch screen with its button kit attached, and then slide it off.
 - (3) Disconnect the ribbon cable.

NOTE: To connect the ribbon cable to the button kit, make sure that the signal surface faces down.

- (4) Remove the screw (with external toothed washer) that secures the ground cable, and then disconnect the LCD cable.
- (5) Disconnect the USB cable.
- (6) Disconnect the power cable.

NOTE: To connect the LCD cable to the LCD touch screen, make sure of the correct orientation of the connector (so that its convex part faces up).

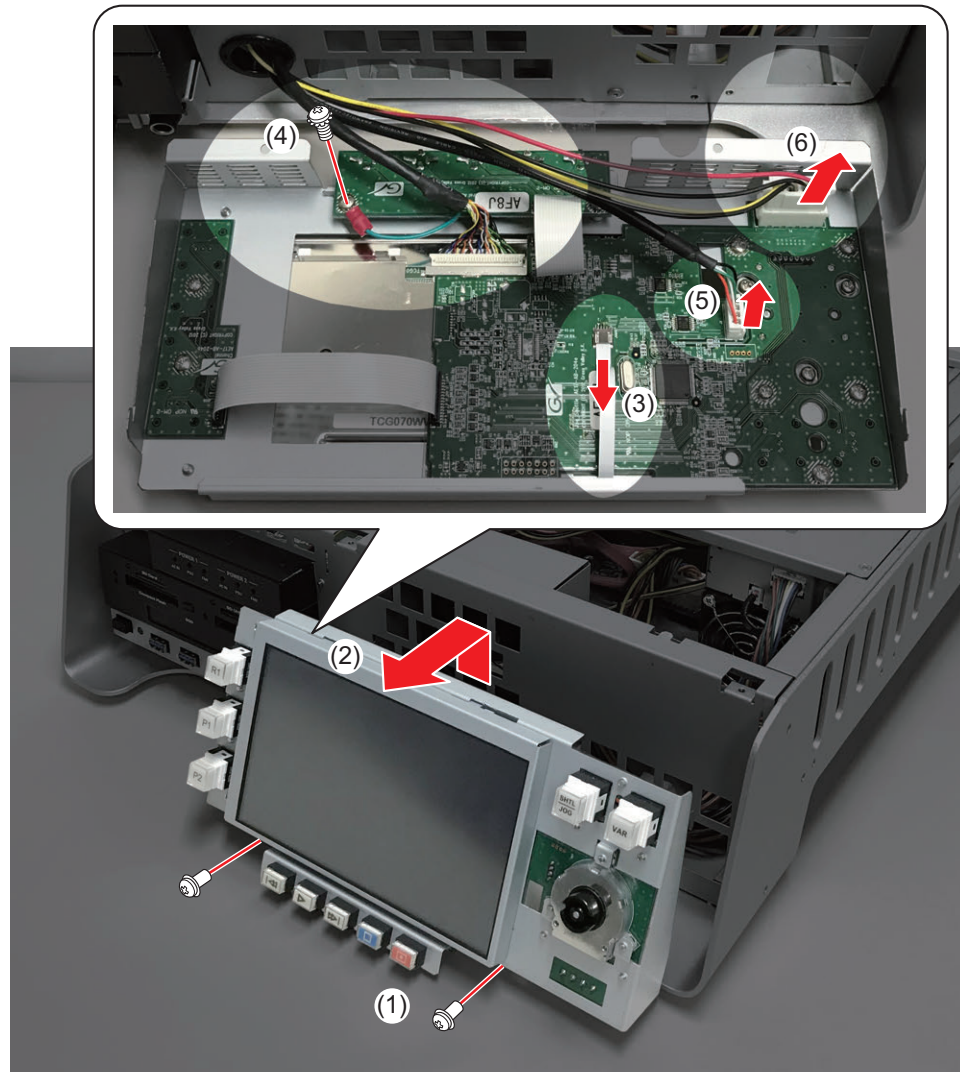

NOTE: To install the LCD touch screen, with its button kit attached to it, to T2, let the prongs of the button kit slide into the (a) parts of T2.

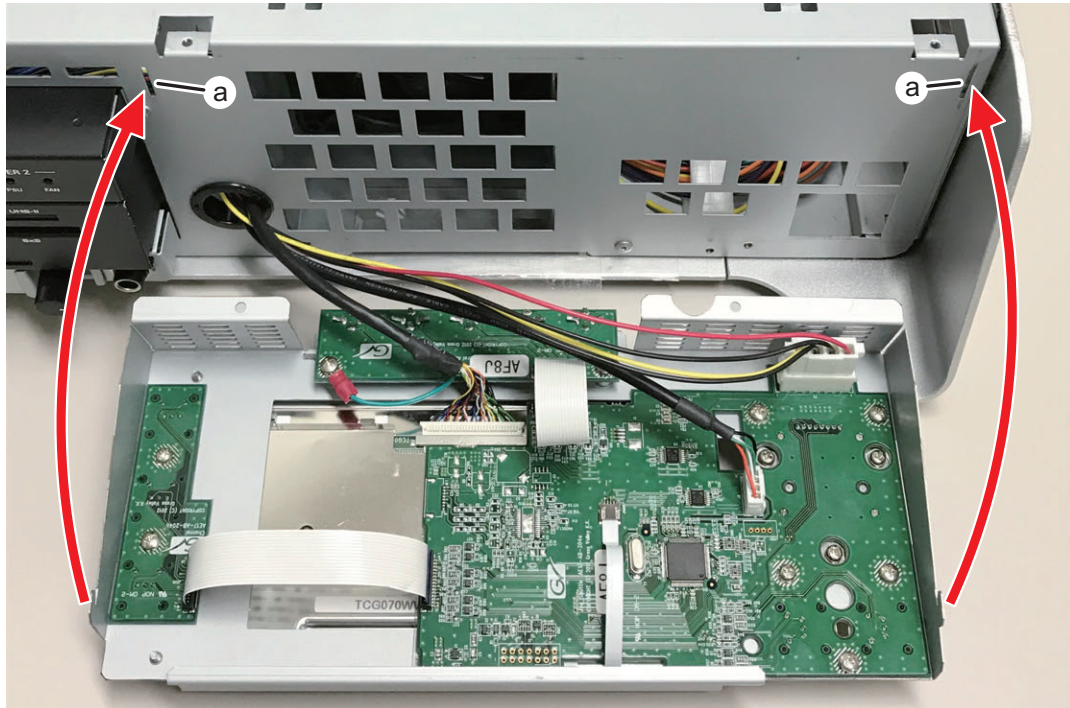

3. Slide the LCD touch screen on the button kit.
 - (1) Remove two screws (with springs and small washers).
 - (2) Slide off the LCD touch screen.

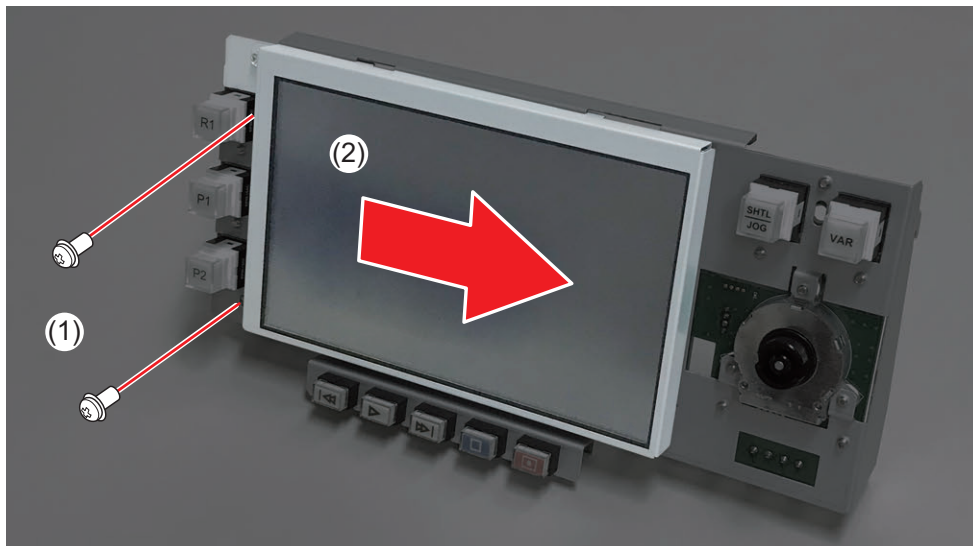

4. Remove the stay and LCD mask sheet attached to the LCD touch screen.

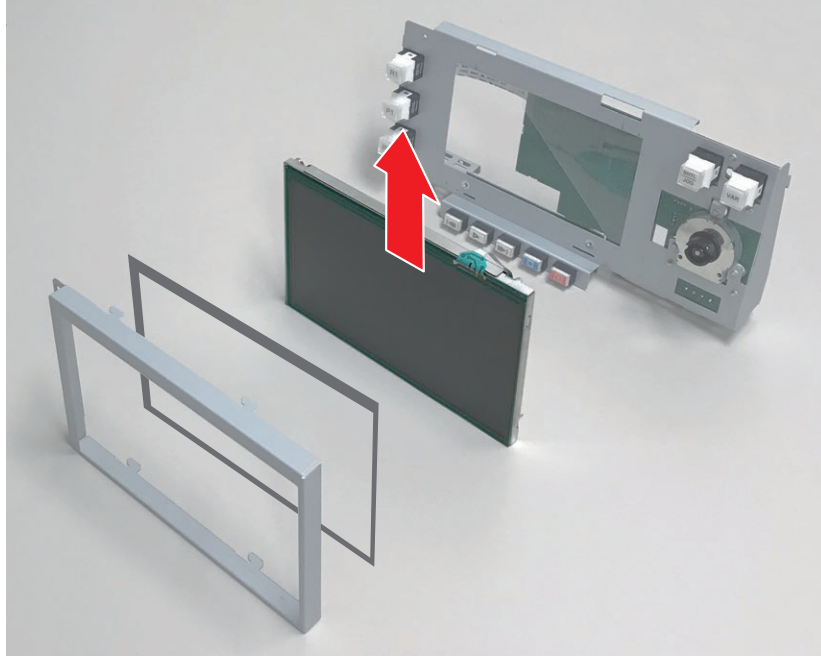

NOTE: To attach the stay, make sure that up, down, right, and left directions are correct.

NOTE: To attach the LCD touch screen onto the button kit, thread the ribbon cable into the slit on the upper part of the button kit.

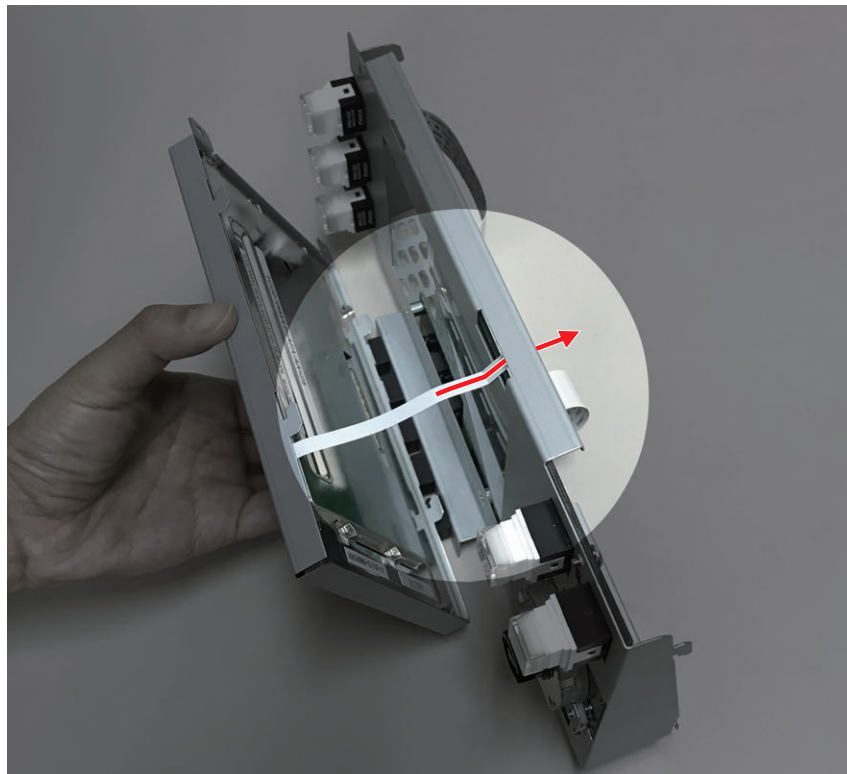

Removing the button kit

1. Perform the procedure for "[Removing the LCD touch screen](#)" on page 81 up to step 3.
2. Remove the button kit from the LCD touch screen.

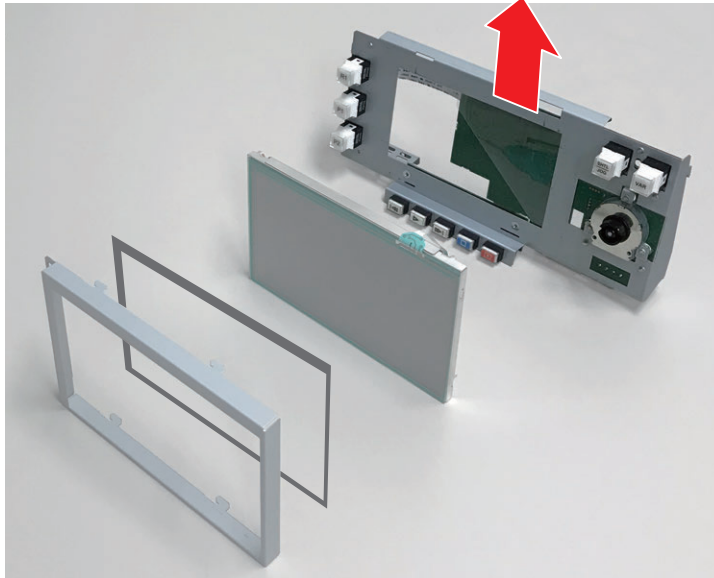

Removing RAM module

1. Removing the top cover (rear). (→P66)
2. Remove the RAM module.
 - (1) Press and open the levers on both ends outward at the same time to lift the RAM module off from slot “2” or “4”.

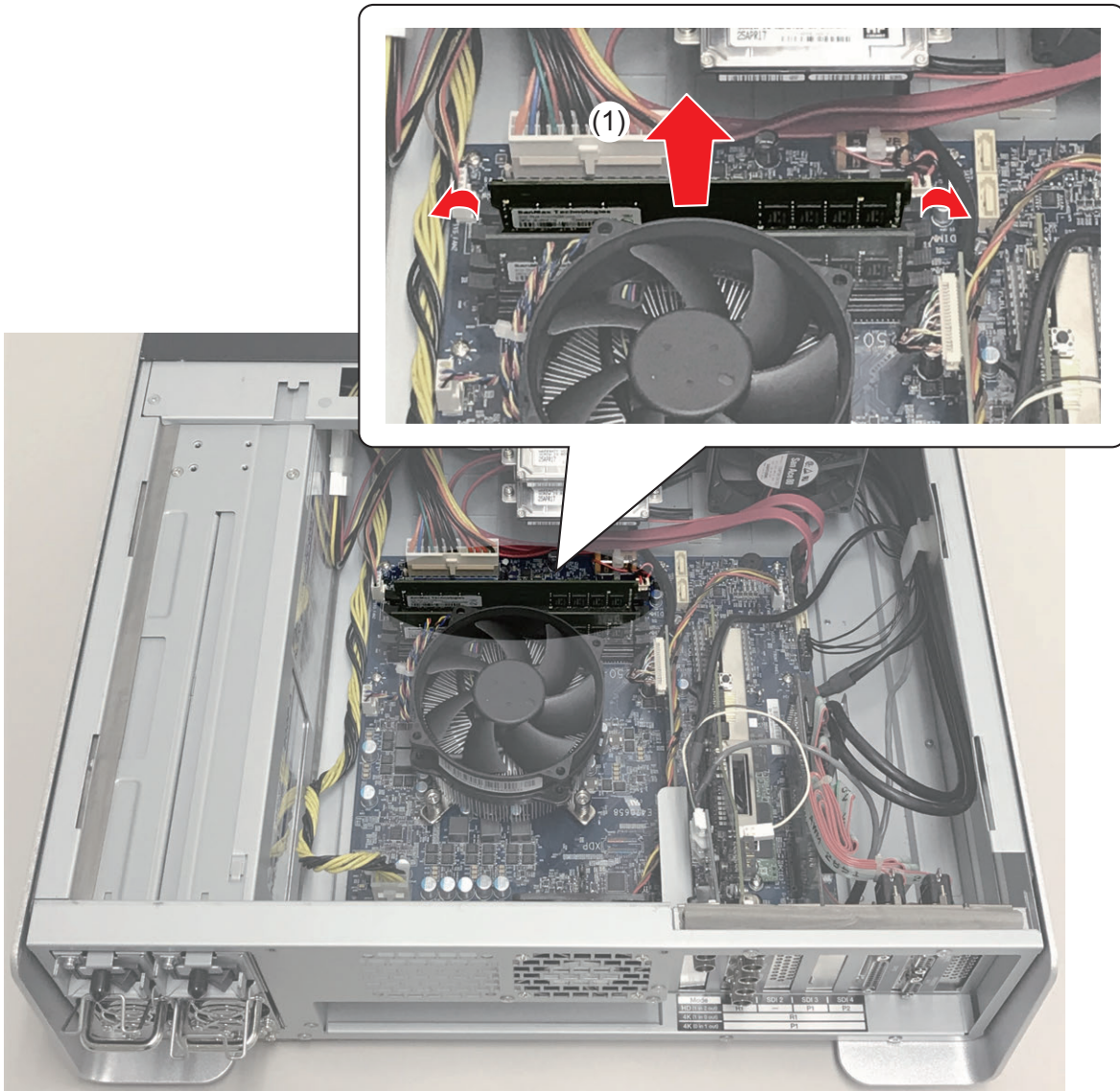

NOTE: To install the RAM module into the slot, insert it perpendicular to the slot until it clicks into place.

Removing the mid-cooling fan

1. Removing the top cover (rear). (→P66)
2. Remove the drive/cooling fan mount plate.
 - (1) Remove four countersunk screws.
 - (2) Lift off the drive/cooling fan mount plate.

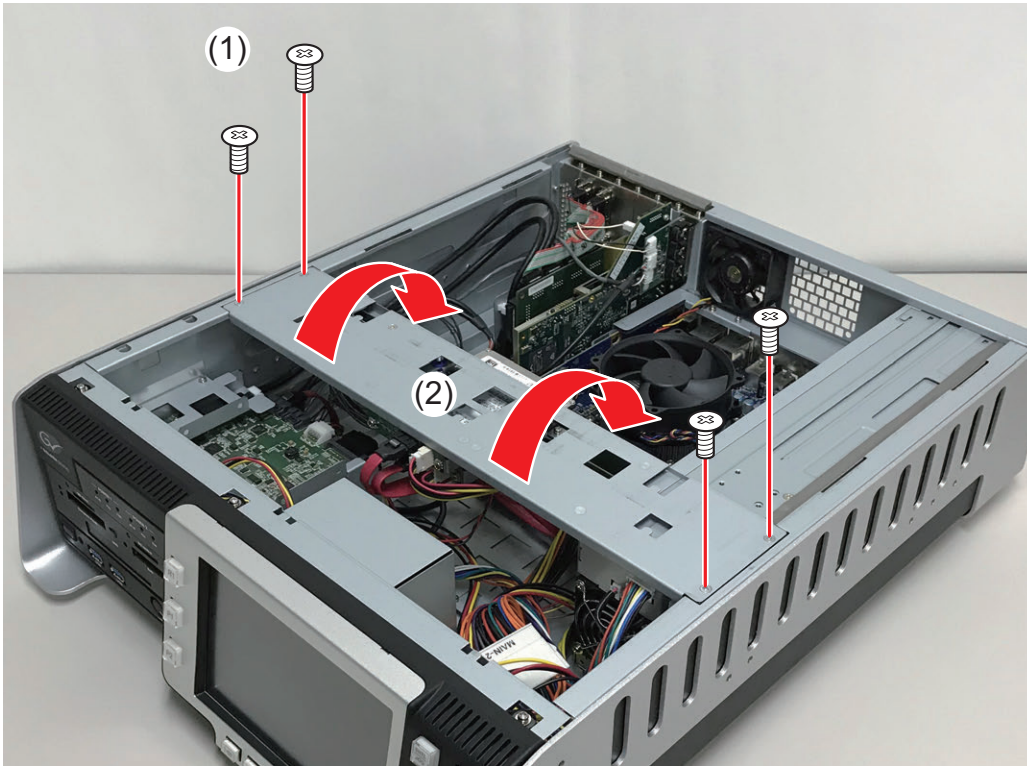

3. Disconnect the power cable of the mid-cooling fan.

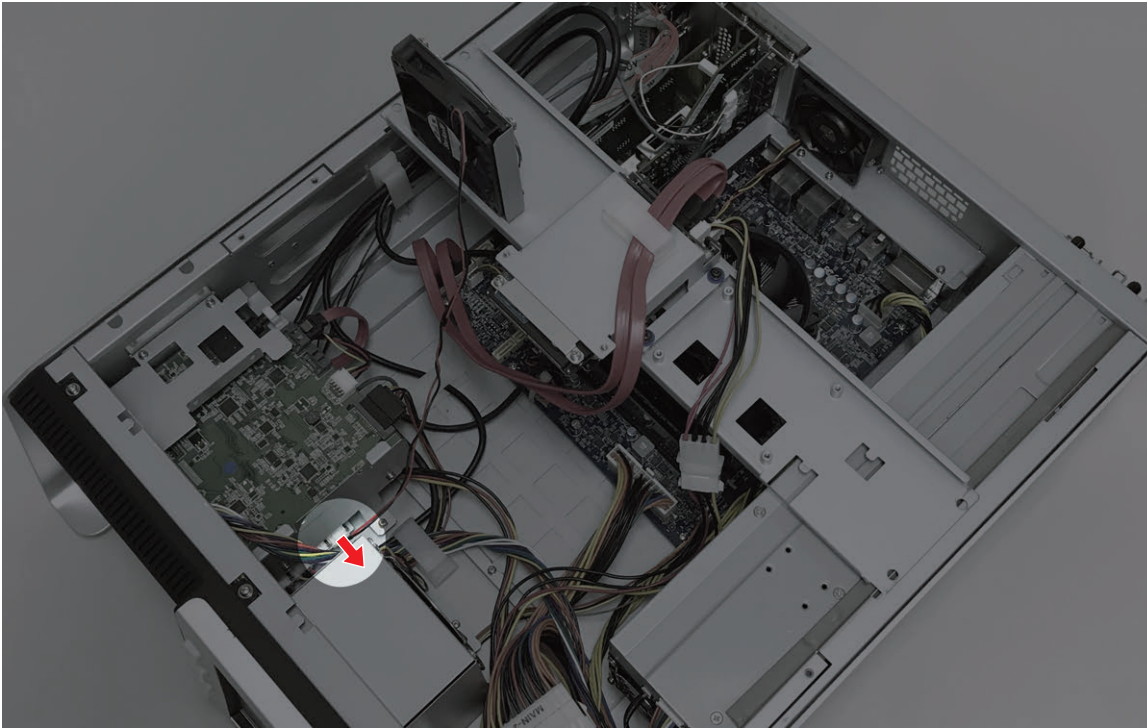

4. Remove the mid-cooling fan from the drive/cooling fan mount plate.

(1) Remove two countersunk screws.

(2) Remove the mid-cooling fan.

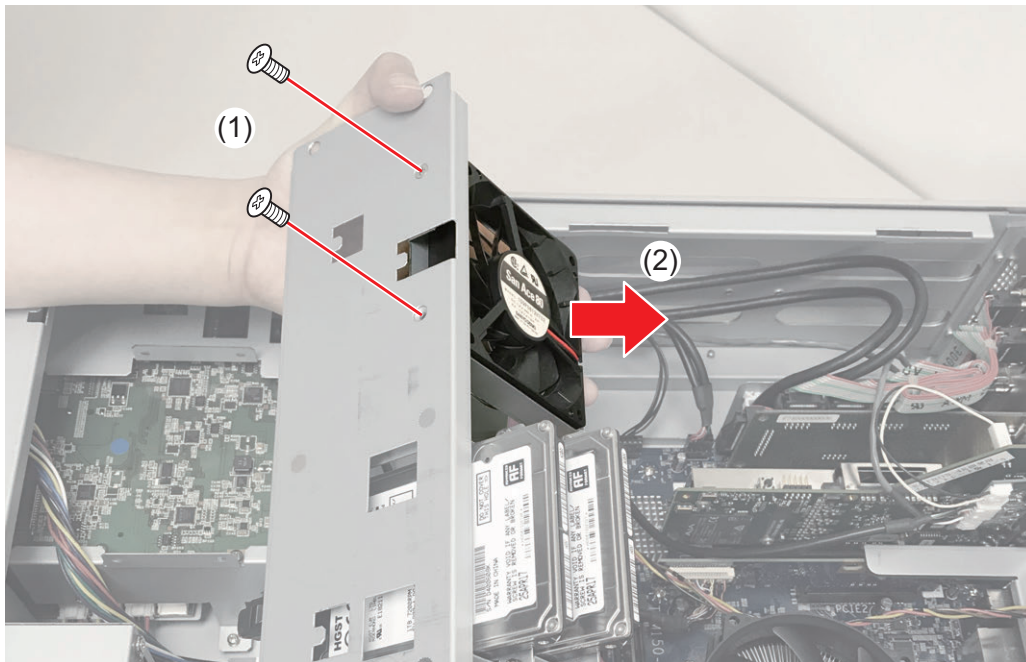

5. Detach the mid-cooling fan from the fan bracket.
 - (1) Remove the tapping screws.
 - (2) Detach the mid-cooling fan.

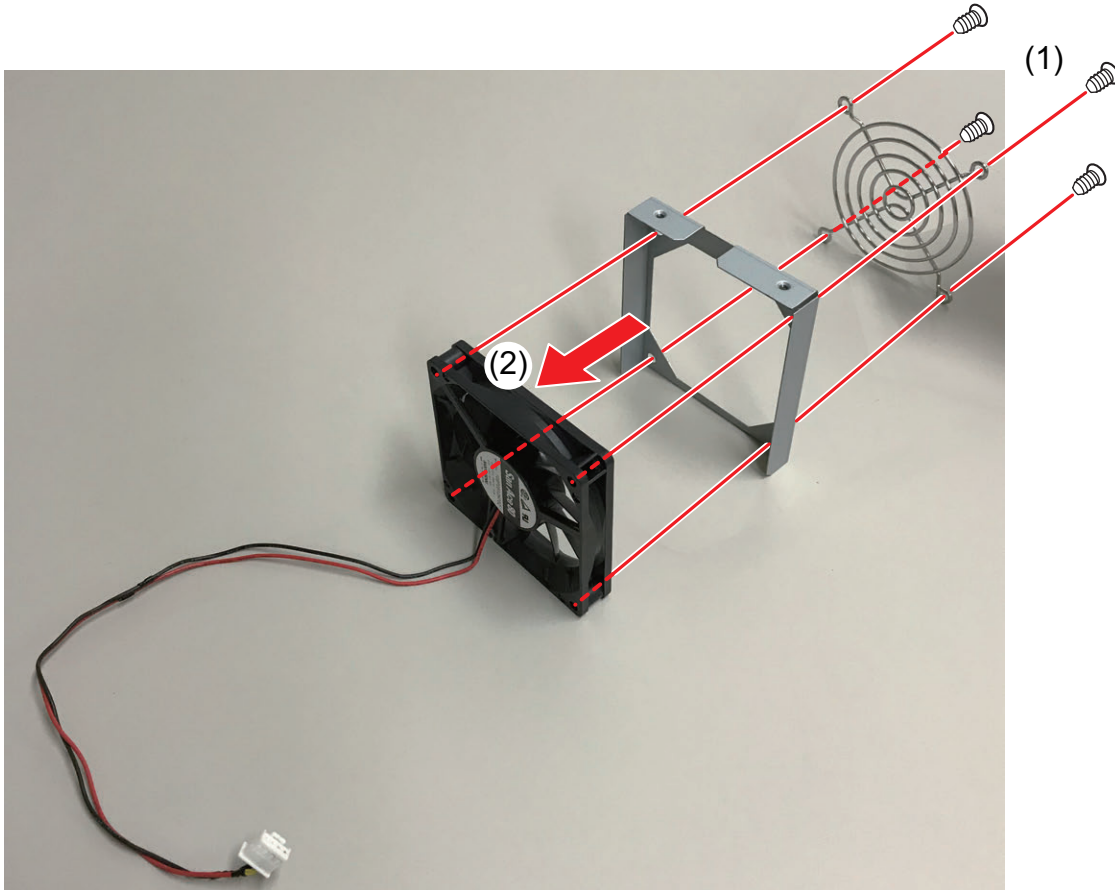

NOTE: To attach the fan to the fan bracket, make sure that the label faces the direction shown in the figure. Also be sure to attach it so that the fan bracket and power cable come to the positions shown in the figure above.

Removing the front cooling fan

1. Perform the procedure for "[Removing the mid-cooling fan](#)" on page 86 up to step 3.
2. Remove the front cooling fan assy.
 - (1) Disconnect the fan power cable from the motherboard.
 - (2) Remove the screw (with a spring and small washer).
 - (3) Remove the front cooling fan assy.

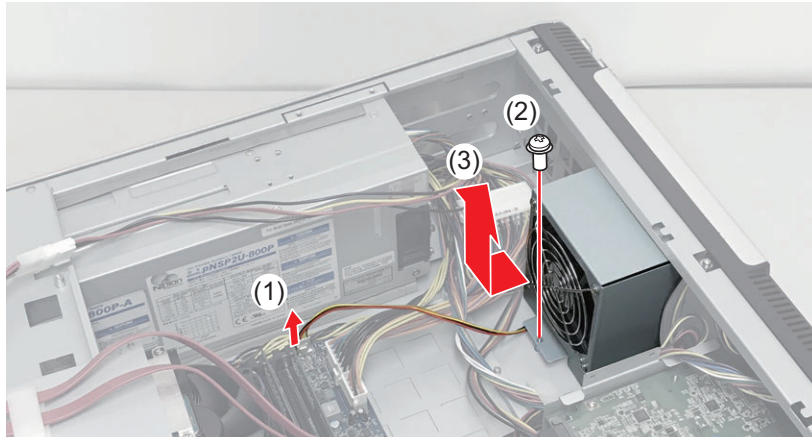

3. Detach the front cooling fan from the fan bracket.
 - (1) Remove the tapping screws.
 - (2) Detach the front cooling fan.

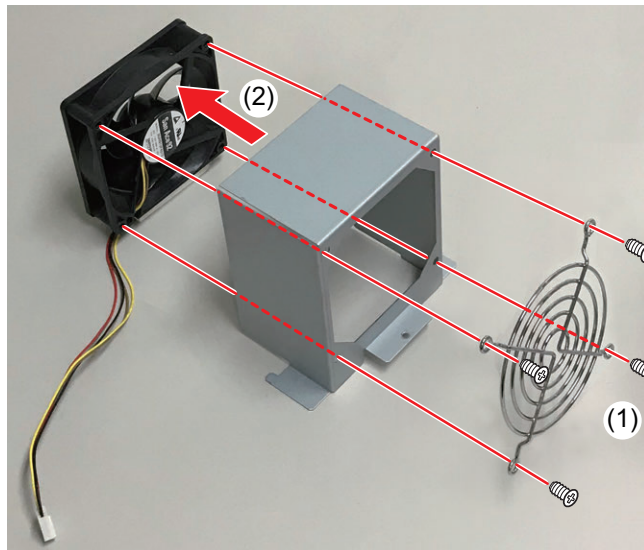

NOTE: To attach the fan to the fan bracket, make sure of their directions shown in the figure above.

Removing the rear fan

1. Removing the top cover (rear). (→P66)
2. Remove the rear fan.
 - (1) Disconnect the power cable.
 - (2) Remove the tapping screws.
 - (3) Slide then lift the rear fan from the rear panel.

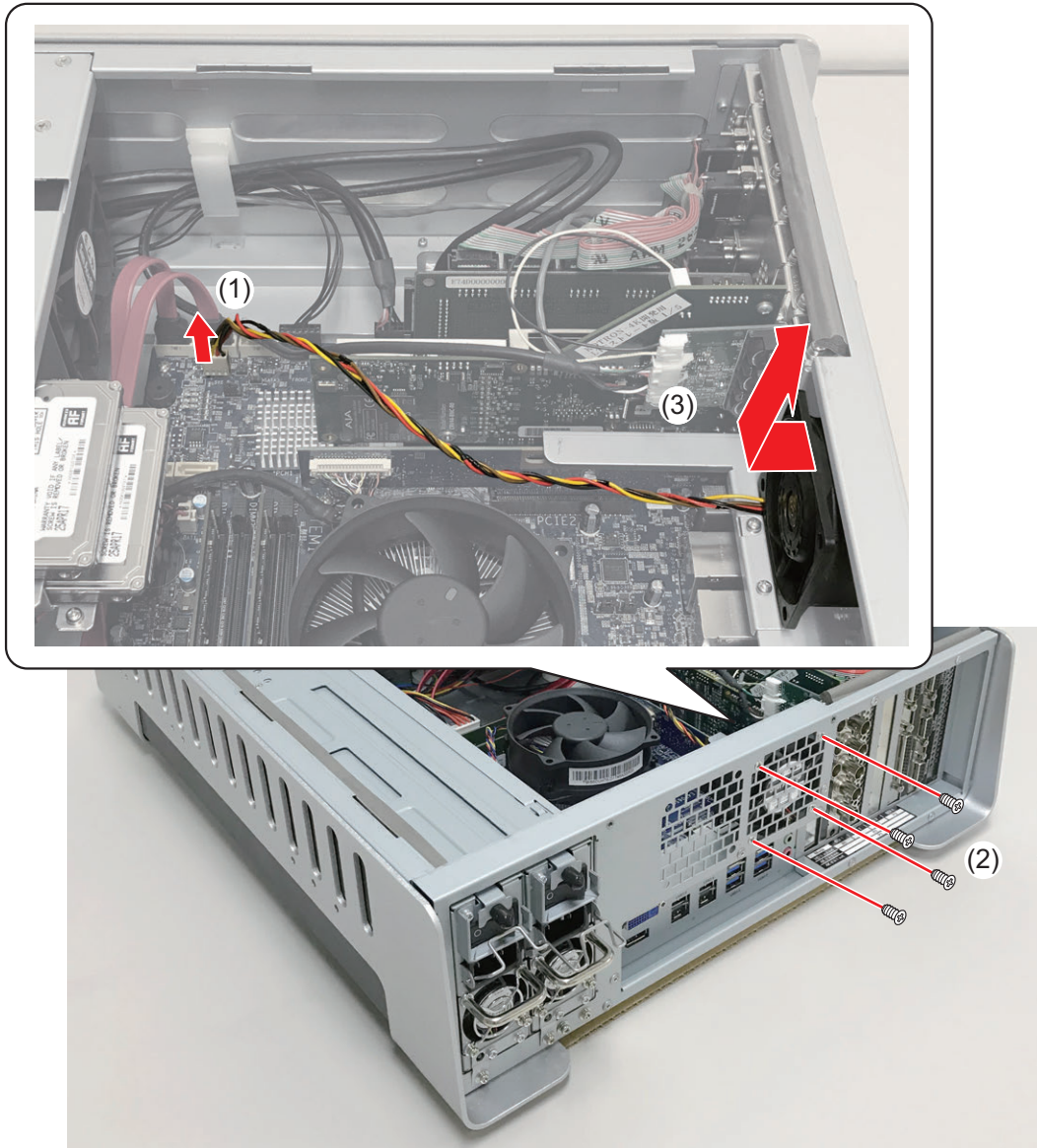

NOTE: To attach the fan, make sure that the label faces the rear panel.

Removing LTC/Monitor audio interface board

1. Removing the top cover (rear). (→P66)
2. Remove the shield gasket.

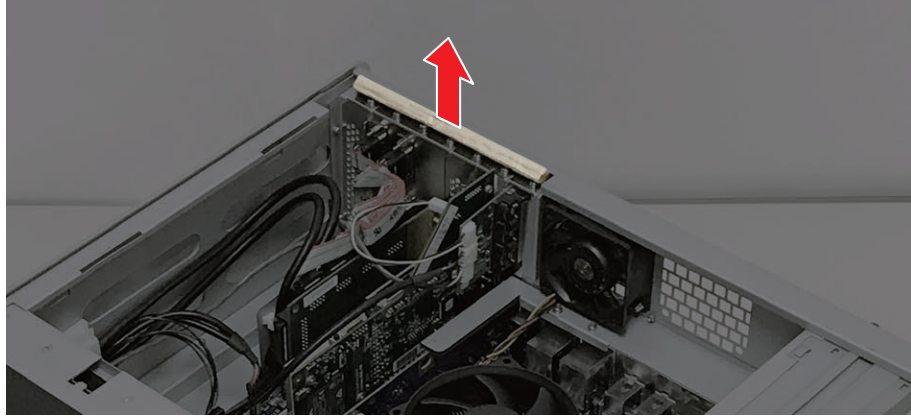

NOTE: When the boards are to be attached, use a new shield gasket.

3. Disconnect following cables from the LTC/Monitor audio interface board.
 - (1) The LTC In cable
 - (2) The power cable of the LTC/Monitor audio interface board
 - (3) The LTC Out/Monitor audio Out cable

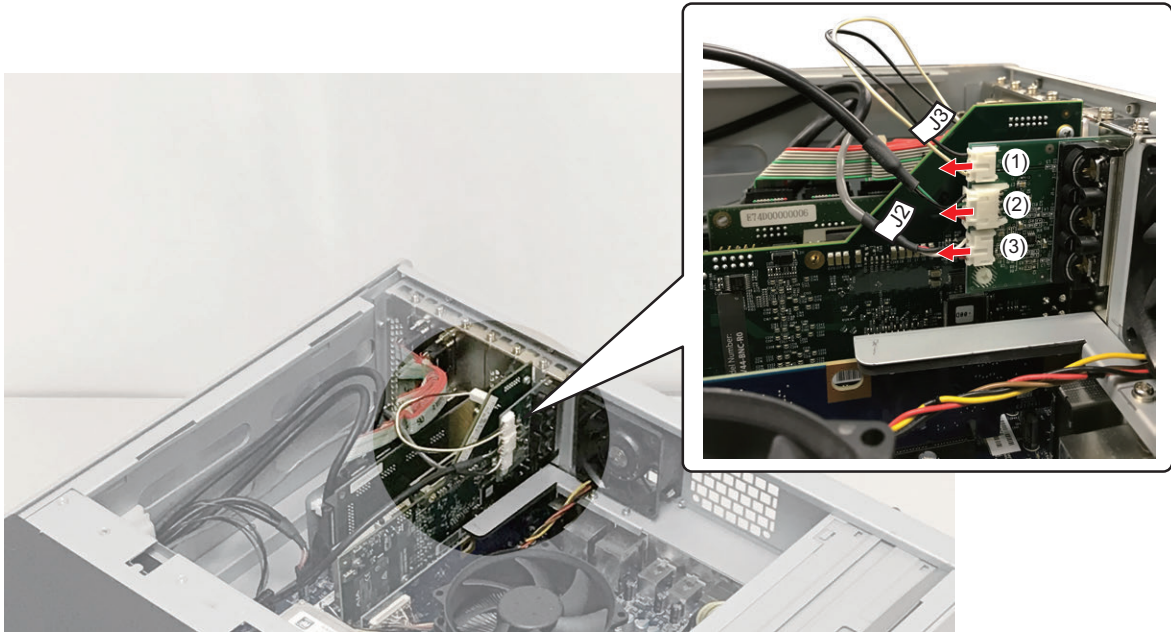

4. Remove the VGA card fixing bracket.
 - (1) Remove the screw (with a spring and small washer).
 - (2) Remove the VGA card fixing bracket.

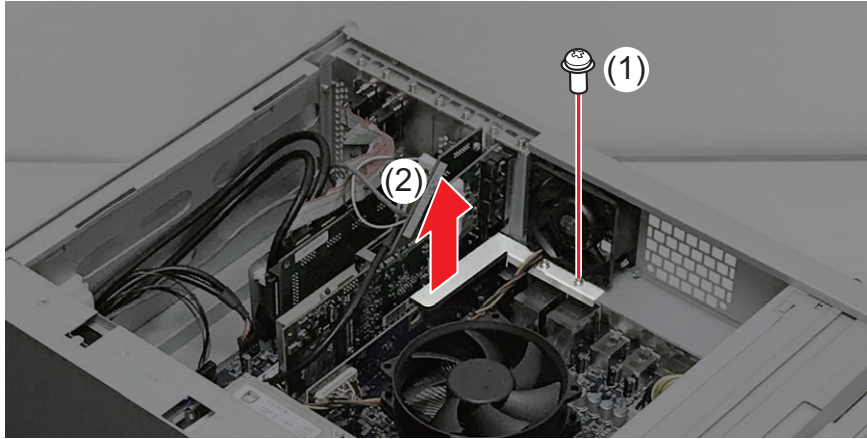

NOTE: To attach the VGA card fixing bracket, make sure that the power cable of the rear fan comes over the bracket.

5. Remove the LTC/Monitor audio interface board.
 - (1) Remove the screw (with a spring and large washer) on the upper side of the LTC/Monitor audio interface board.
 - (2) Remove the LTC/Monitor audio interface board from the slot.

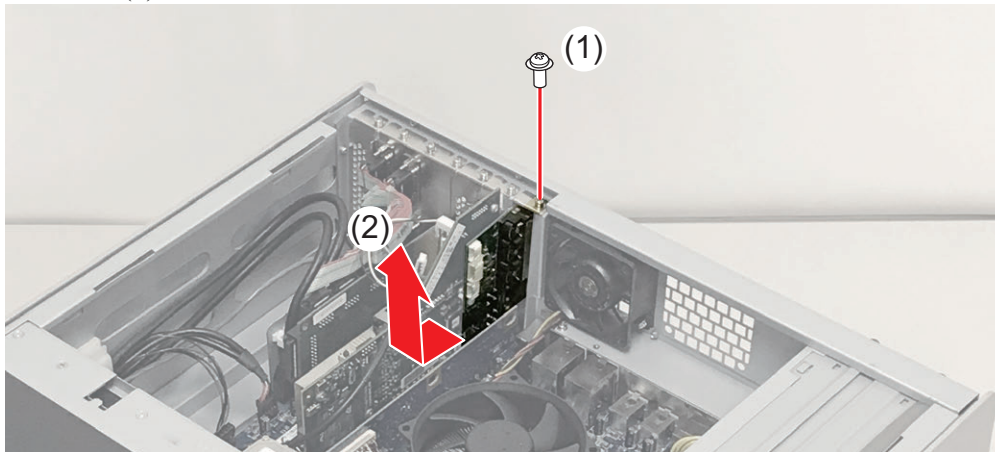

Removing the video I/O board

1. Perform the procedure for "[Removing LTC/Monitor audio interface board](#)" on [page 91](#) up to step 3.
2. Remove the video I/O board.
 - (1) Remove the screw (with a spring and large washer) on the upper side of the video I/O board.
 - (2) Remove the video I/O board from the slot.

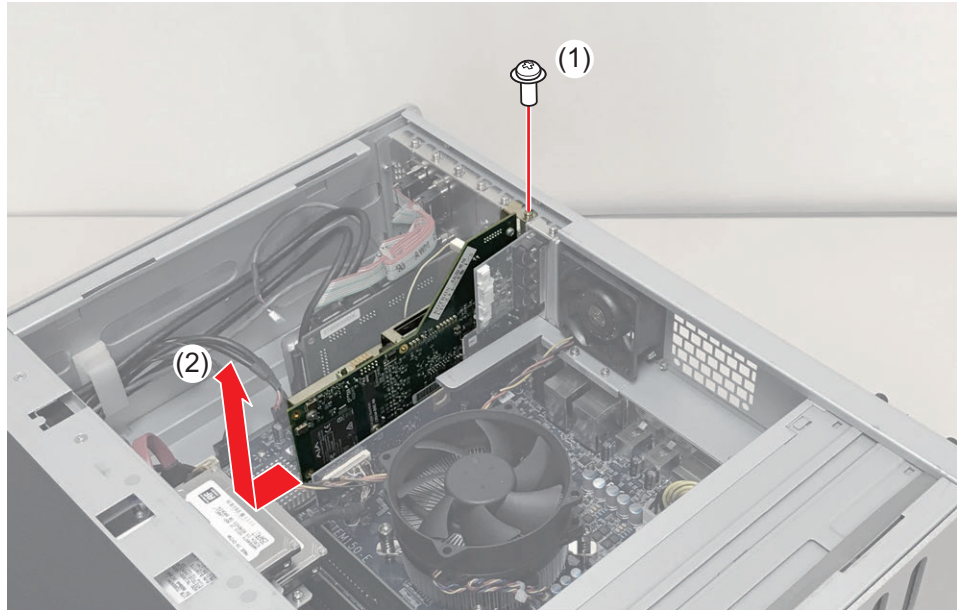

NOTE: To install the video I/O board, insert it into the PCI Express x16 slot.

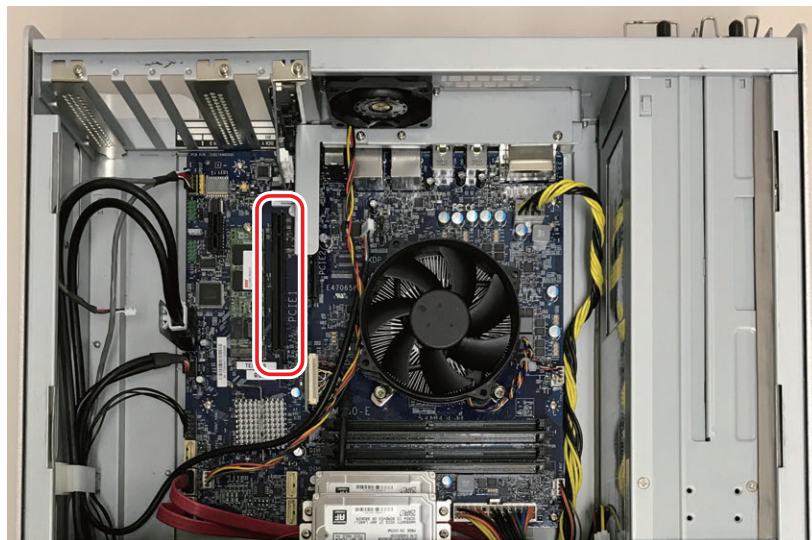

Removing the remote interface board

1. Perform the procedure for "[Removing LTC/Monitor audio interface board](#)" on [page 91](#) up to step 3.
2. Remove the remote interface board.
 - (1) Remove three screws (with springs and large washers) on the upper side of the remote interface board.
 - (2) Remove the remote interface board from the slot.

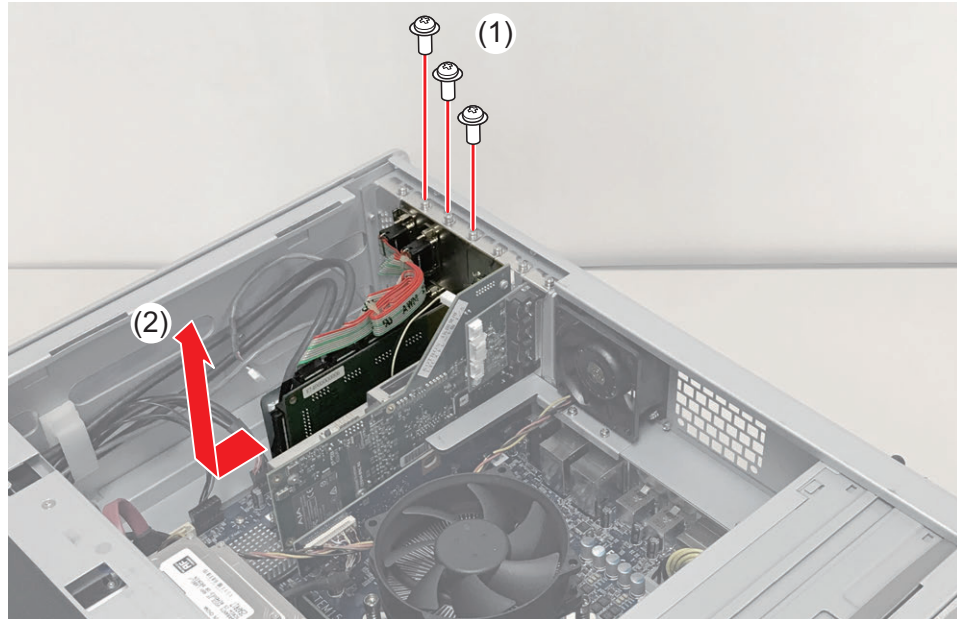

NOTE: To install the remote interface board, insert it into the PCI Express x1 slot.

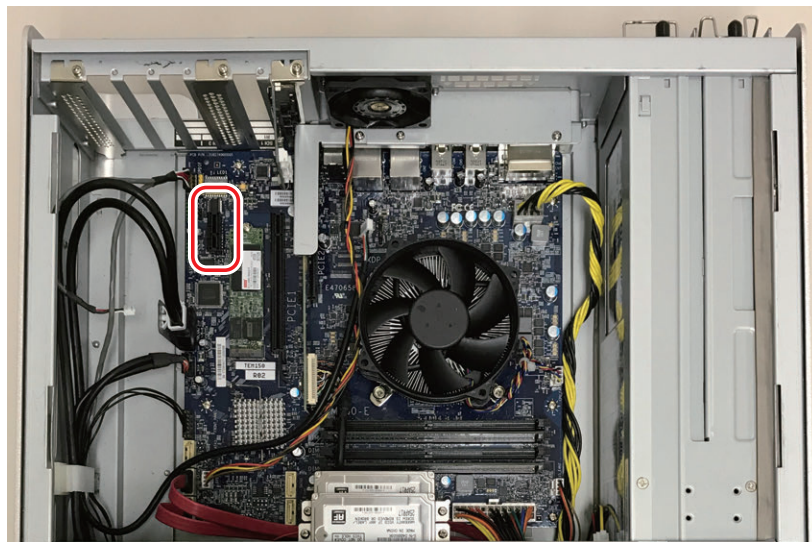

Removing VGA card

1. Removing the top cover (rear). (→P66)
2. Remove the VGA card securing bracket.
 - (1) Remove the screw (with a spring and small washer).
 - (2) Remove the VGA card fixing bracket.

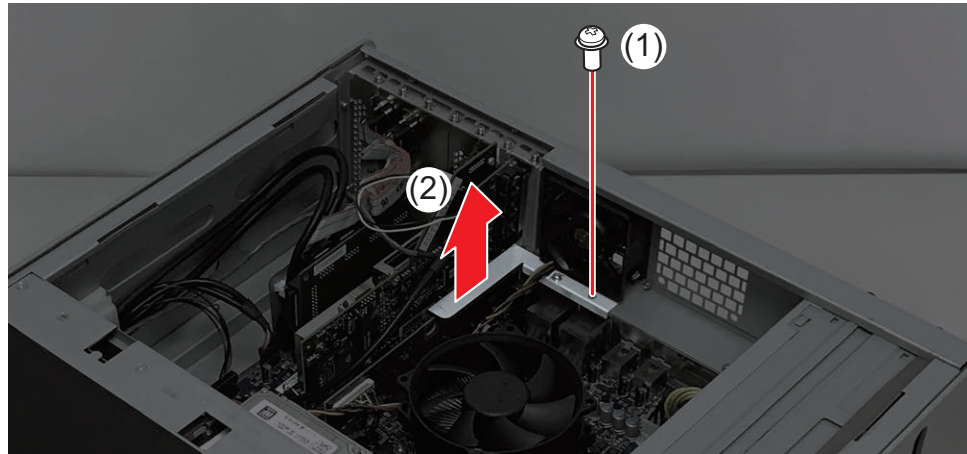

3. Remove the VGA card.
 - (1) Remove the VGA card.
 - (2) Disconnect the LVDS cable.

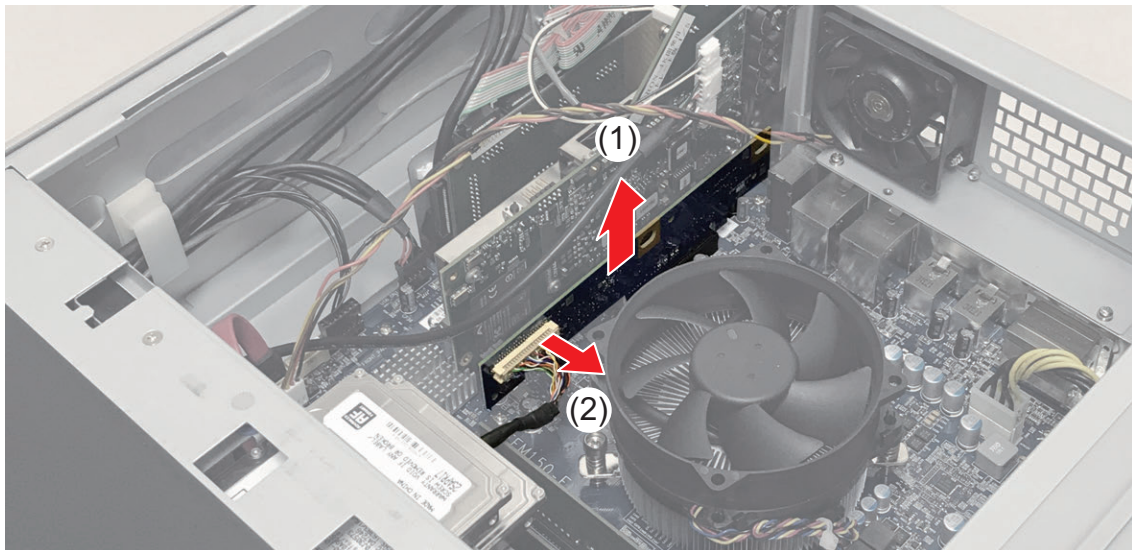

Removing the power supply unit

1. Turning off the T2 and disconnecting the power cord. (→P64)
2. Remove the power supply unit.
 - (1) Remove the screw (with a spring and large washer).
 - (2) Keep to press the power supply unit lock lever (a) and slide out the power supply unit by holding the handle (b).

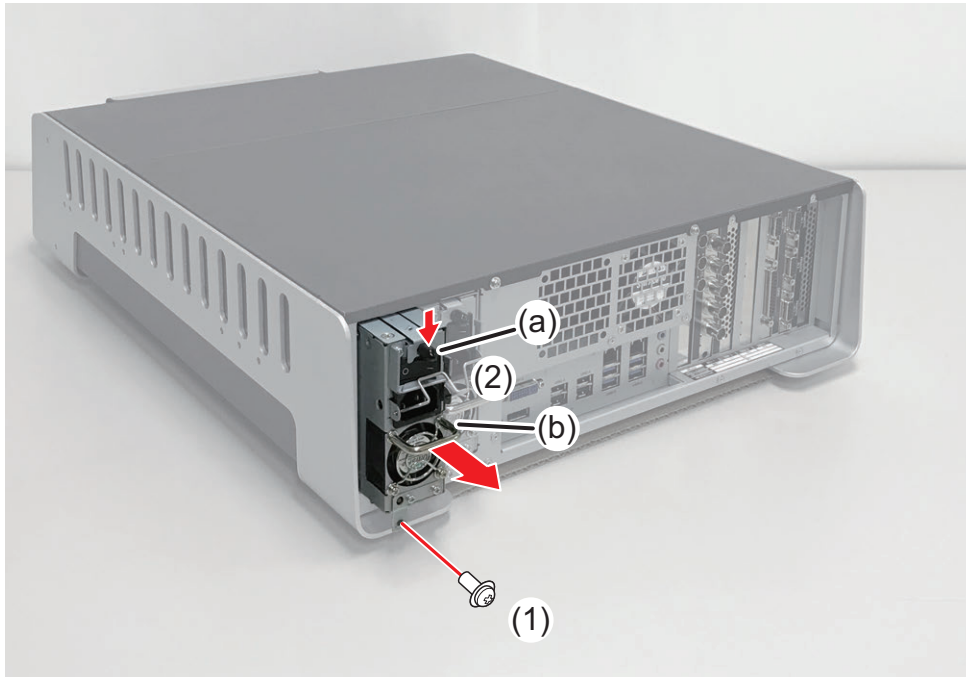

Removing the power supply unit enclosure

1. Perform the procedure for "[Removing the mid-cooling fan](#)" on page 86 up to step 3.
2. Removing the power supply unit. (→P96)
3. Remove the screws.
 - (1) Remove the two screws (with springs and large washers).
 - (2) Remove the screw (with a spring and small washer).
 - (3) Unlock the cable clamber and disconnect the cable.

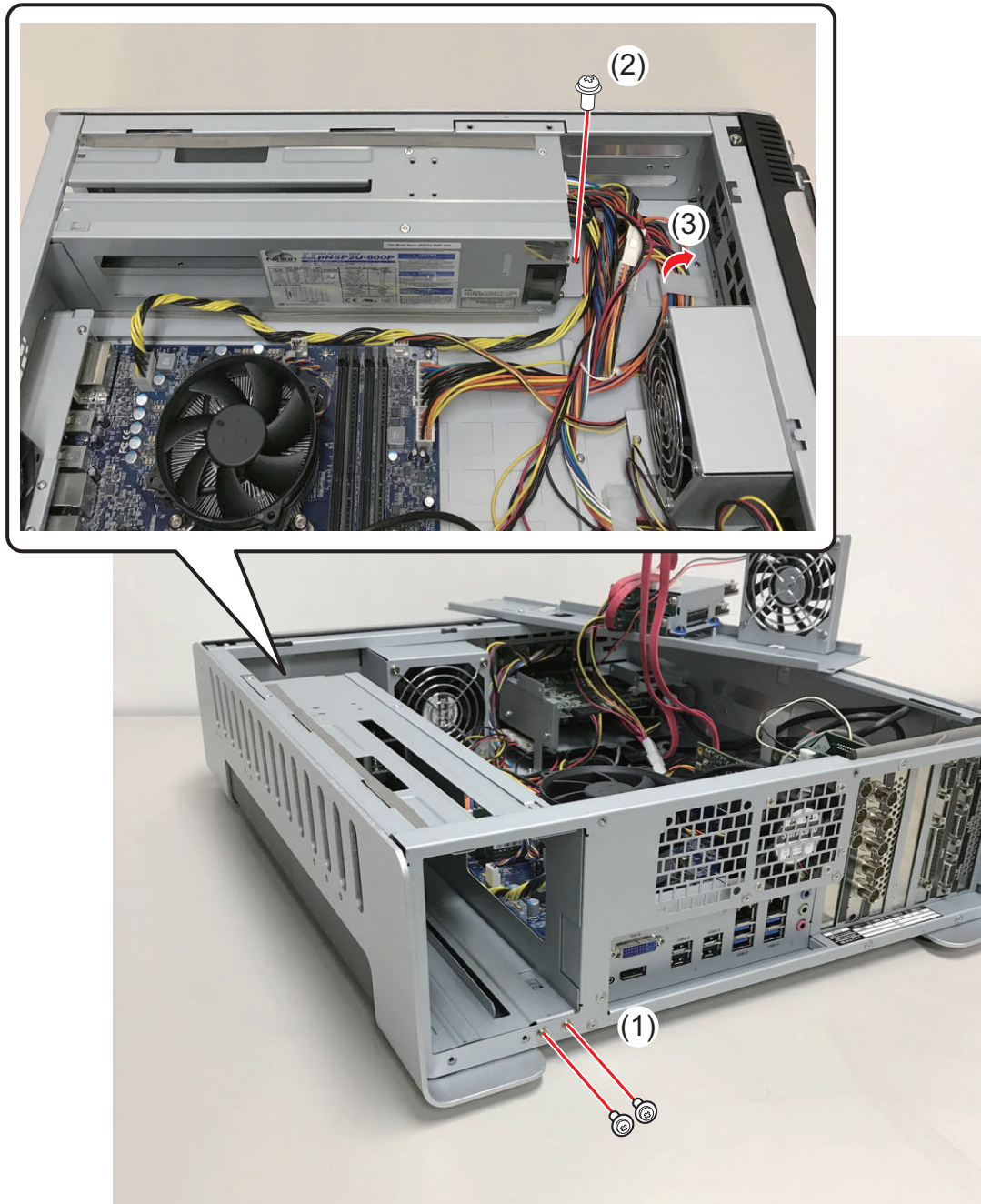

4. Remove the power supply unit enclosure.

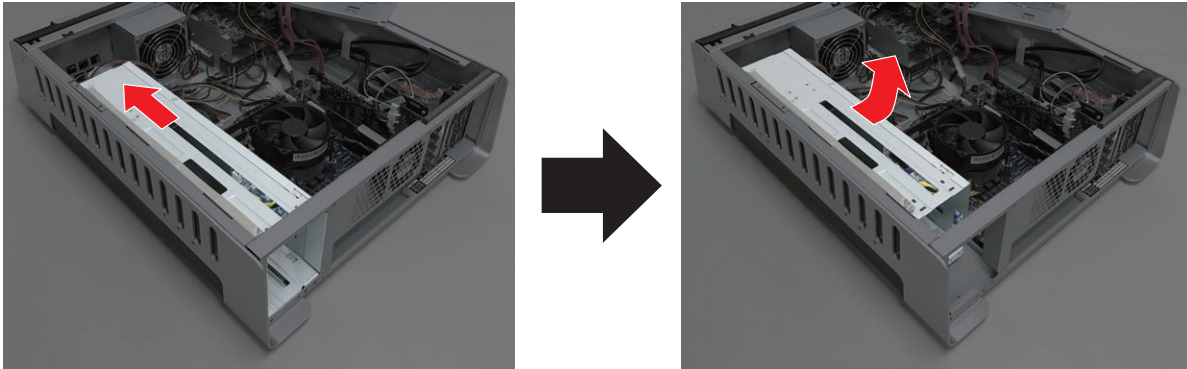

5. Disconnect the cables.

- (1) The power supply status signal cable
- (2) The CPU power cable (8-pin)
- (3) The drive power supply cable (10-pin)
- (4) The PSU main cable

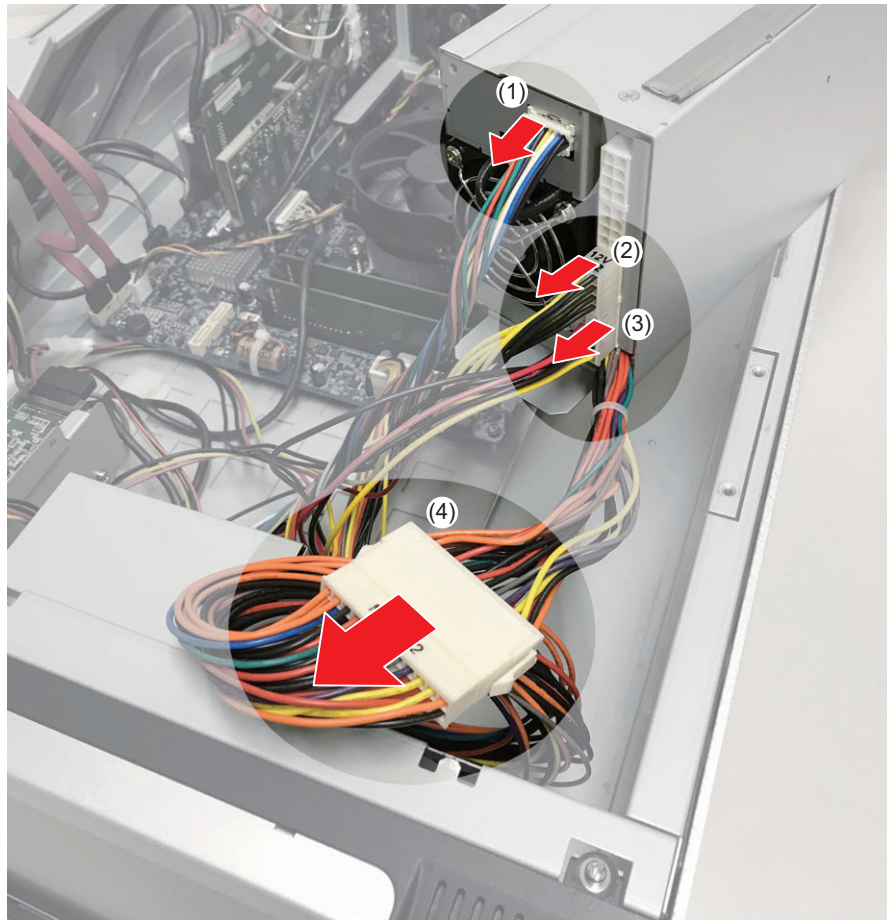

Index

B

- Battery replacement 6
- BIOS
 - Startup 54
- Button kit
 - Troubleshooting 57
 - Replacement procedure 84

C

- Canadian Certified Power Cords 7
- Canadian EMC Notice of Compliance 7
- Certifications and compliances 7
- CommandCenter 18, 20
- CommandCenter mode 18
- CPU
 - Troubleshooting 61

D

- Data
 - Backup 29
 - Consistency 26
 - Initialize 28
 - Maintenance 26
 - Restore 31
- Data HDD
 - Replacement procedure 69
- Data SSD
 - Replacement procedure 69
- Database
 - Troubleshooting 60
- Defragmentation 24

E

- EMC Directive 1/2 Class A Warning 8
- External equipment
 - Troubleshooting 53

F

- Fan
 - Troubleshooting 55
 - Replacement procedure 86, 89, 90
- FCC Emission Control and Limits 7, 8
- Field Replaceable Unit (FRU) 64
- Front Control group unit
 - Description 13

- Front panel
 - Removing and installing 76
- Front Subsystem 13
- Front USB group unit
 - Description 13
 - Troubleshooting 57
 - Replacement procedure 77
- Frozen video
 - Troubleshooting 61
- FRU
 - Location 15
 - Replacement procedure 63

I

- Injury precautions 5

J

- Jog knob
 - Troubleshooting 57
 - Replacement procedure 77

K

- Keyboard
 - Troubleshooting 53

L

- LAN port LED status 16
- LCD touch screen
 - Cleaning 18
 - Replacement procedure 81
 - Troubleshooting 56
- LED 16
- Log files
 - Exporting 34
- LTC/Monitor audio interface board
 - Replacement procedure 91

M

- Maintenance mode
 - Access 19
 - Description 18
 - Exit 20
- Maintenance tools
 - Description 22

- Exit 22
- Media card reader
 - Troubleshooting 58
- Media card reader assy
 - Replacement procedure 74
- Media drive
 - Defragmentation 24
 - Error check 23
 - Maintenance 23
 - Troubleshooting 60, 61
 - Replacement procedure for data HDD 69
 - Replacement procedure for data SSD 69
- Media file system
 - Troubleshooting 60
- Motherboard
 - Startup 54
- Mouse
 - Troubleshooting 54

O

- Operation
 - Troubleshooting 59
- Operation buttons
 - Procedure 56

P

- Password 19
- PC monitor
 - Troubleshooting 53
- PC Subsystem 13
- Power cable clamp
 - Removing and installing 65
- Power supply
 - Troubleshooting 55
- Power supply status LED board
 - Replacement procedure 72
- Power supply unit
 - Replacement procedure 96
- Power supply unit enclosure
 - Replacement procedure 97
- Product damage precautions 5

R

- RAID
 - Build 38
 - Troubleshooting 61
 - Verify 36

- RAM module
 - Replacement procedure 85
- Recovery 49
- Remote interface board
 - Replacement procedure 94
- Required tools 64
- Restart problems 52
- Restoring the default system 49
- RJ-45 LAN port
 - LEDs 16

S

- Safety terms and symbols 6
- Service safety summary 7
- Shutdown problems 52
- Shuttle knob
 - Troubleshooting 57
 - Replacement procedure 77
- Status indicators 16
- Storage system
 - Troubleshooting 61
- System
 - Description 12
 - Information 32
 - Maintenance 32
- System SSD
 - Troubleshooting 60
 - Replacement procedure 71
- System USB stick 49
 - Replacement procedure 80

T

- T2
 - Startup 55
- Temperature
 - Troubleshooting 55
- Timecode
 - Troubleshooting 59
- Top cover
 - Removing and installing 66, 67
- Troubleshooting
 - Preliminary steps 51

V

- Ventilation 5
- VGA card
 - Replacement procedure 95

Video I/O board
Replacement procedure 93
Type 14